

DESCRIPTIVE BULLETIN

# ReliaGear® SB switchboard

## On Demand program



- Onsite delivery in just two weeks
- Seven pre-configured designs with flexible breaker settings
- Catalog number driven for easy ordering
- Reduce project cycle times

---

**ReliaGear® SB On Demand program from ABB for low voltage switchboard allows customers to have onsite delivery in just two weeks.\***

**The On Demand program offers seven pre-configured designs with flexible breaker settings, helping customers gain a competitive edge by potentially reducing project cycle times.**

\* Items must be in stock to meet two-week delivery timeframe. Please check empower Flow for current availability. 10-week mid cycle also available.

---

# Table of contents

<b>004–005</b>	<b>On Demand program overview</b>
<b>007</b>	<b>ReliaGear® SB 2000 A</b>
<b>008</b>	<b>ReliaGear® SB 2000 A add-on feeder section</b>
<b>009</b>	<b>ReliaGear® SB 4000 A</b>
<b>010</b>	<b>ReliaGear® SB 4000 A add-on feeder section</b>
<b>012</b>	<b>ReliaGear® SB 2000 A NEMA 3R</b>
<b>013</b>	<b>ReliaGear® SB 4000 A NEMA 3R</b>
<b>014</b>	<b>ReliaGear® SB 4000 A add-on feeder section NEMA 3R</b>

# On Demand program

## Overview

The On Demand program for ReliaGear® SB switchboard offers customers two-week or 10-week lead times and the option to choose between seven universal, pre-configured switchboard designs.

With an installed base of thousands of units worldwide, ReliaGear SB switchboard sets the standard for functionality, flexibility, and rugged, durable construction.

ABB's On Demand program builds on this reputation by providing customers the opportunity to easily order and quickly receive delivery of ReliaGear SB switchboard in just two weeks.\* The On Demand program can potentially reduce project cycle times, helping customers gain a competitive advantage wherever 24/7 reliability is an absolute necessity.

### On Demand program highlights

- Onsite delivery in as few as two weeks
- Seven pre-configured designs with flexible breaker settings
- Catalog number driven for easy ordering
- Potentially reduces project cycle times

### Why ReliaGear SB?

The universal design of ReliaGear SB switchboard allows substantial flexibility for a wide variety of customer applications. The modular assembly of the plug-in style connections helps reduce maintenance and assembly time.

This innovative design approach and trip unit flexibility also facilitates field reconfiguration creating the ability to achieve a wide range of trip settings.

The flexible design of SACE® Emax2 and Tmax® XT breakers also allows for simple field adjustments to be made to meet a wide variety of applications. Combined with the ReliaGear plug-in style distribution section bus stack, customers can quickly and easily move breaker locations to provide maximum flexibility.

\* Items must be in stock to meet two-week delivery timeframe. Please check empower Flow for current availability. 10-week mid cycle also available.



The flexible design of SACE® Emax2 and Tmax® XT breakers allows for simple field adjustments to be made to meet a wide variety of applications.



### Features and benefits

- Main bus, 2000 A or 4000 A, copper bus
- Emax2 main device with GF and RELT
- 480/277 V AC maximum @ 100 kAIC
- ReliaGear plug-in panel type for easy installation of breakers
- Fully rated bus with provision for future extensions
- Front access only with hinged doors
- Front and rear alignment for splicing sections
- Features XT dip trip units for maximum flexibility
- RGM 2200 (2000 A) and RGM 6000 (4000 A) digital power meter provided
- Qualified for seismic ratings per publication 9AKK108466A5933 and OSP-0044-10
- Enclosures available in NEMA Type 1 and 3R

### Configurations available On Demand

The On Demand program offers seven pre-configured ReliaGear SB designs:

- ReliaGear® SB 2000 A
- ReliaGear® SB 2000 A add-on feeder section
- ReliaGear® SB 4000 A
- ReliaGear® SB 4000 A add-on feeder section
- ReliaGear® SB 2000 A NEMA 3R
- ReliaGear® SB 4000 A NEMA 3R
- ReliaGear® SB 4000 A NEMA 3R add-on feeder section

Pages 7 through 14 show detailed drawings of these seven configurations.

### Ordering

ReliaGear® SB switchboard On Demand catalog numbers have been added to both empower Flow and empower Quote. If adding in empower Quote, it is important to ensure there is adequate stock at the time of quotation/order entry.

There are a limited number of these configurations available at any given time and inventory will be dynamic due to the expected demand.

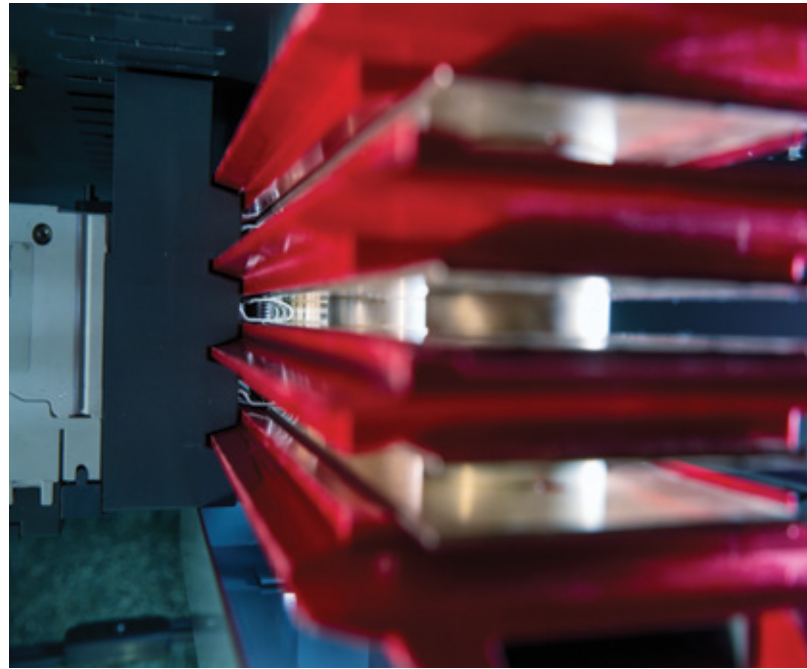



# NEMA 1 offering



# ReliaGear® SB 2000 A

Catalog# SWBSTS20E (2-week cycle)  
SWBSTS20E-M (10-week cycle)

ReliaGear® SB  
switchboard

ACCESS TO: Front Only	PHASE: 3P4W
CLASS: 2	AMPERE: 2000
LABEL: U/L SE	BUS MTL: Cu 1000A / in <sup>2</sup>
VOLTAGE: 480Y/277V	PLATE: Silver Plate
STYLE: ReliaGear	RATING: Fully
BUS BRACING (RMS SYM)	100000 A
DEV. MIN. INT. RATING (RMS SYM)	100000 A
Total Line Up Width: 70	

**Feeders**

- 8 – XT4 250 A (dial down to 100 A)
- 2 – XT5 600 A (dial down to 240 A)
- 2 – XT4 Spaces (future expansion)

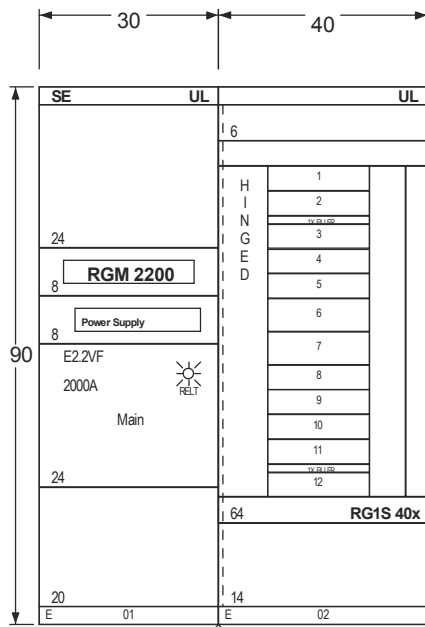

Front View

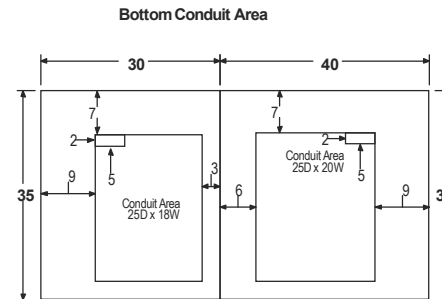
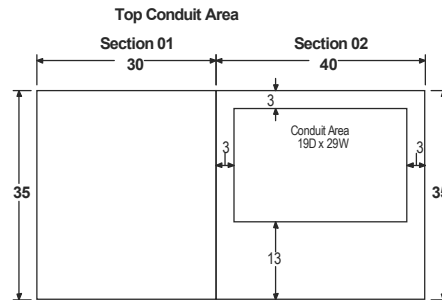

Switchboard/Device Information

Circuit No.	Device	Amps	Poles	Nameplates	Lugs	Notes
Main	SH	2000	3			11,12,13,14,15
1	XT4L250	100	3	(Space and Bus)	AI (1) #4 - 300 MCM Cu Cbl	9
2	XT4L250	100	3	(Space and Bus)	AI (1) #4 - 300 MCM Cu Cbl	9
3	XT4L250	250	3		AI (1) 3/0 - 350 MCM Cu Cbl	8
4	XT4L250	250	3		AI (1) 3/0 - 350 MCM Cu Cbl	8
5	XT4L250	250	3		AI (1) 3/0 - 350 MCM Cu Cbl	8
6	XT5L600	600	3		AI (2) 2/0 - 500 MCM Cu Cbl	8
7	XT5L600	600	3		AI (2) 2/0 - 500 MCM Cu Cbl	8
8	XT4L250	250	3		AI (1) 3/0 - 350 MCM Cu Cbl	8
9	XT4L250	250	3		AI (1) 3/0 - 350 MCM Cu Cbl	8
10	XT4L250	250	3		AI (1) 3/0 - 350 MCM Cu Cbl	8
11	XT4L250	250	3		AI (1) 3/0 - 350 MCM Cu Cbl	8
12	XT4L250	250	3		AI (1) 3/0 - 350 MCM Cu Cbl	8

NOTES:

- Copper ground bus furnished.
- Equipment ground bus furnished with lugs.
- Switchboard furnished with Nameplates.
- Shipping splits between each section, ship each section separately.
- RGM 2200 Meter Modbus RS485 + Pulse installed in Switchboard. See drawing SWBSTS20EWD.
- Switchboard furnished with hinged gutter covers.
- Switchboard furnished with fully rated panel.
- Device furnished with EKIP DIP (LSI) programmer.
- Device furnished with TMA programmer.
- Provision For Future Extension.
- Device is furnished with 24V - 48V DC Ekip Supply.
- Device is furnished with 250V Bell Alarm.
- Device is furnished with 400V (4Q) Auxiliary Contacts.
- Device furnished with 400V (4Q) Auxiliary Contacts.
- Device furnished with EKIP Touch LSI trip unit.
- Equipment is furnished to work with 480/277 V and 208/120V. See drawing SWBSTS20EWD to select the operating voltage. Control circuit is unplugged, customer is responsible to connect the correct voltage source.

# ReliaGear® SB 2000 A add-on feeder section\*

Catalog# SWBSTS20EDIST (2-week cycle)  
 SWBSTS20EDIST-M (10-week cycle)

ReliaGear® SB  
switchboard

ACCESS TO: Front Only	PHASE: 3P4W
CLASS: 1	AMPERE: 2000
LABEL: U/L	BUS MTL: Cu 1000A / in <sup>2</sup>
VOLTAGE: 480Y/277V	PLATE: Silver Plate
STYLE: ReliaGear	RATING: Fully
BUS BRACING (RMS SYM)	100000 A
DEV. MIN. INT. RATING (RMS SYM)	100000 A
Total Line Up Width: 40	

**Feeders**

- 8 – XT4 250 A (dial down to 100 A)
- 2 – XT5 600 A (dial down to 240 A)
- 2 – XT4 Spaces (future expansion)

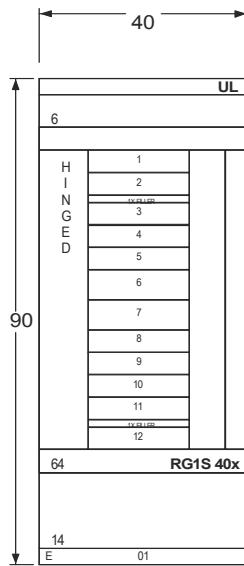

Front View

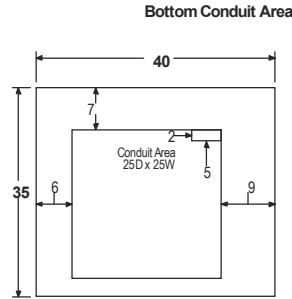
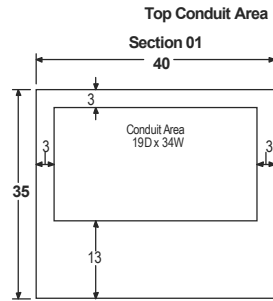

Circuit No.	Device	Amps	Poles	Nameplates	Lugs	Notes
1	XT4L250	100	3	(Space and Bus)	AI (1) #4 - 300 MCM Cu Cbl	7
2	XT4L250	100	3	(Space and Bus)	AI (1) #4 - 300 MCM Cu Cbl	7
3	XT4L250	250	3		AI (1) 3/0 - 350 MCM Cu Cbl	6
4	XT4L250	250	3		AI (1) 3/0 - 350 MCM Cu Cbl	6
5	XT4L250	250	3		AI (1) 3/0 - 350 MCM Cu Cbl	6
6	XT5L600	600	3		AI (2) 2/0 - 500 MCM Cu Cbl	6
7	XT5L600	600	3		AI (2) 2/0 - 500 MCM Cu Cbl	6
8	XT4L250	250	3		AI (1) 3/0 - 350 MCM Cu Cbl	6
9	XT4L250	250	3		AI (1) 3/0 - 350 MCM Cu Cbl	6
10	XT4L250	250	3		AI (1) 3/0 - 350 MCM Cu Cbl	6
11	XT4L250	250	3		AI (1) 3/0 - 350 MCM Cu Cbl	6
12	XT4L250	250	3		AI (1) 3/0 - 350 MCM Cu Cbl	6

**NOTES:**

- 1 Copper ground bus furnished.
- 2 Equipment ground bus furnished with lugs.
- 3 Switchboard furnished with Nameplates.
- 4 Switchboard furnished with hinged gutter cover.
- 5 Switchboard furnished with fully rated panel.
- 6 Device furnished with EKIP DIP (LSI) programmer.
- 7 Device furnished with TMA programmer.
- 8 Provision for future extension.

\*Applied only as an "add-on" section to SWBSTS20E or SWBSTS20E-M



# ReliaGear® SB 4000 A

## Catalog# SWBSTS40E (2-week cycle)

## SWBSTS40E-M (10-week cycle)

ReliaGear® SB  
switchboard

ACCESS TO: Front Only	PHASE: 3P4W
CLASS: 2	AMPERE: 4000
LABEL/UL SE	BUS MTL: Cu 1000A / in <sup>2</sup>
VOLTAGE: 480V/277V	PLATE: Silver Plate
STYLE: ReliaGear	RATING: Fully
BUS BRACING (RMS SYM)	100000 A
DEV. MIN. INT. RATING (RMS SYM)	100000 A
Total Line Up Width: 90	

**Feeders**

- 3 – XT4 250 A (dial down to 100 A)
- 2 – XT5 600 A (dial down to 240 A)
- 2 – XT7 1200 A (dial down to 480 A)
- 5 – XT4 spaces (future expansion)

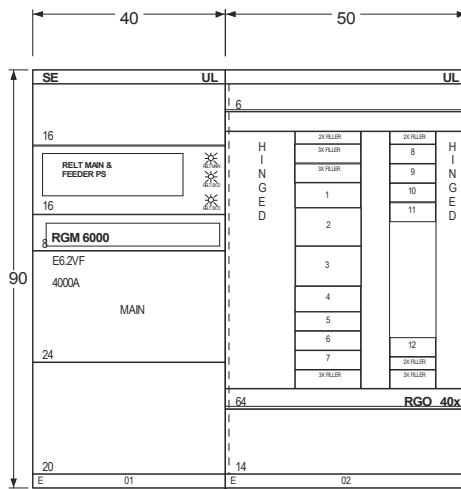

Front View

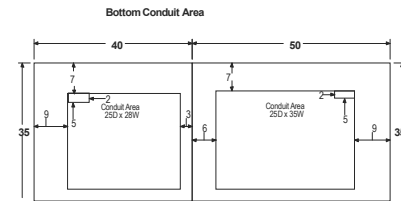
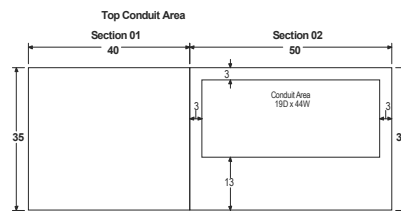

Switchboard/Device Information

Circuit No.	Device	Amps	Poles	Nameplates	Lugs	Notes
1	E6.2VF	4000	3		AI (2) 2/0 - 500 MCM Cu Cbl	15,16,17,18,19,20,21
2	XT5L600	600	3		AI (4) 4/0 - 500 MCM Cu Cbl	8
3	XT7L1200	1200	3		AI (4) 4/0 - 500 MCM Cu Cbl	9,10,13,14
4	XT5L600	600	3		AI (2) 2/0 - 500 MCM Cu Cbl	8
5	XT4L250	100	3	(Space and Bus)	AI (1) #4 - 300 MCM Cu Cbl	11
6	XT4L250	100	3	(Space and Bus)	AI (1) #4 - 300 MCM Cu Cbl	11
7	XT4L250	250	3		AI (1) 3/0 - 350 MCM Cu Cbl	8
8	XT4L250	250	3		AI (1) 3/0 - 350 MCM Cu Cbl	8
9	XT4L250	250	3		AI (1) 3/0 - 350 MCM Cu Cbl	8
10	XT4L250	100	3	(Space and Bus)	AI (1) #4 - 300 MCM Cu Cbl	11
11	XT4L250	100	3	(Space and Bus)	AI (1) #4 - 300 MCM Cu Cbl	11
12	XT4L250	100	3	(Space and Bus)	AI (1) #4 - 300 MCM Cu Cbl	11

NOTES:

- 1 Copper ground bus furnished.
- 2 Equipment ground bus furnished with lugs.
- 3 Switchboard furnished with Nameplates.
- 4 Shipping splits between each section, ship each section separately.
- 5 RGM6000 Meter installed in Switchboard. See drawing SWBSTS40EWD.
- 6 Switchboard furnished with hinged gutter covers.
- 7 Switchboard furnished with fully rated panel.
- 8 Device furnished with EKIP DIP (LSI) programmer.
- 9 Device furnished with EKIP Touch (LSIG) programmer.
- 10 Device furnished with RELT. See drawing SWBSTS40EWD.
- 11 Device furnished with TMA programmer.
- 12 Provision For Future Extension.
- 13 Device furnished with EKIP RELT Signalling.
- 14 Device furnished with EKIP 24VDC Supply.
- 15 Device is furnished with 24V - 48V DC Ekup Supply.
- 16 Device is furnished with 250V Bell Alarm.
- 17 Device is furnished with RELT-Ekip Signalling 2K3 module.
- 18 Device furnished with (PLC) Open Position - Padlock
- 19 Device furnished with 400V (4Q) Auxiliary Contacts.
- 20 Device furnished with EKIP Touch LSIG trip unit.
- 21 Device furnished with RELT. See drawing SWBSTS40EWD.
- 22 Equipment is furnished to work with 480/277 V and 208/120 V. See drawing SWBSTS40EWD to select the operating voltage. Control circuit is unplugged, customer is responsible to connect the correct voltage source.

# ReliaGear® SB 4000 A add-on feeder section\*

Catalog# SWBSTS40EDIST (2-week cycle)  
 SWBSTS40EDIST-M (10-week cycle)

ReliaGear® SB  
switchboard

ACCESS TO: Front Only	PHASE: 3P4W
CLASS: 1	AMPERE: 4000
LABEL: J/L	BUS MTL: Cu 1000A / in <sup>2</sup>
VOLTAGE: 480Y/277V	PLATE: Silver Plate
STYLE: ReliaGear	RATING: Fully
BUS BRACING (RMS SYM)	100000 A
DEV. MIN. INT. RATING (RMS SYM)	100000 A
Total Line Up Width: 50	

**Feeders**

- 3 – XT4 250 A (dial down to 100 A)
- 2 – XT5 600 A (dial down to 240 A)
- 2 – XT7 1000 A (dial down to 400 A)
- 5 – XT4 spaces (future expansion)

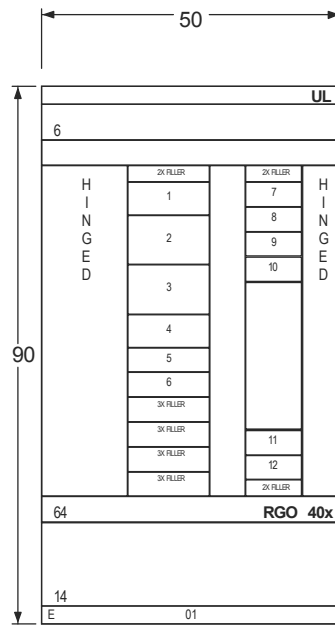

Front View

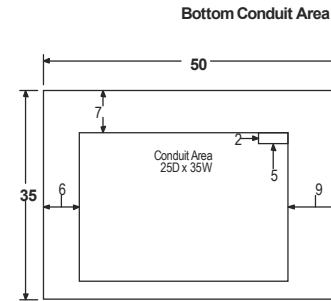
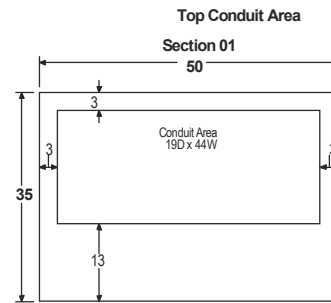

Switchboard/Device Information

Circuit No.	Device	Amps	Poles	Nameplates	Lugs	Notes
1	XT5L600	600	3		Al (2) 2/0 - 500 MCM Cu Cbl	6
2	XT7L1000	1000	3		Al (4) 4/0 - 500 MCM Cu Cbl	9
3	XT7L1000	1000	3		Al (4) 4/0 - 500 MCM Cu Cbl	9
4	XT5L600	600	3		Al (2) 2/0 - 500 MCM Cu Cbl	6
5	XT4L250	100	3	(Space and Bus)	Al (1) #4 - 300 MCM Cu Cbl	7
6	XT4L250	100	3	(Space and Bus)	Al (1) #4 - 300 MCM Cu Cbl	7
7	XT4L250	250	3		Al (1) 3/0 - 350 MCM Cu Cbl	6
8	XT4L250	250	3		Al (1) 3/0 - 350 MCM Cu Cbl	6
9	XT4L250	250	3		Al (1) 3/0 - 350 MCM Cu Cbl	6
10	XT4L250	100	3	(Space and Bus)	Al (1) #4 - 300 MCM Cu Cbl	7
11	XT4L250	100	3	(Space and Bus)	Al (1) #4 - 300 MCM Cu Cbl	7
12	XT4L250	100	3	(Space and Bus)	Al (1) #4 - 300 MCM Cu Cbl	7

NOTES:

- 1 Copper ground bus furnished.
- 2 Equipment ground bus furnished with lugs.
- 3 Switchboard furnished with Nameplates.
- 4 Switchboard furnished with hinged gutter covers.
- 5 Switchboard furnished with fully rated panel.
- 6 Device furnished with EKIP DIP (LSI) programmer.
- 7 Device furnished with TMA programmer.
- 8 Provision For Future Extension.
- 9 Device furnished with EKIP DIP (LSIG) programmer.

\*Applied only as an "add-on" section to SWBSTS40E or SWBSTS40E-M.



# NEMA 3R offering



# ReliaGear® SB 2000 A — NEMA 3R

Catalog# SWBSTS20EN3R (2-week cycle)  
 SWBSTS20EN3R-M (10-week cycle)

ReliaGear® SB  
switchboard

ACCESS TO: Front Only	PHASE: 3P4W
CLASS: 2	AMPERE: 2000
LABEL: J/L SE	BUS MTL: Cu 1000A / in <sup>2</sup>
VOLTAGE: 480Y/277V	PLATE: Silver Plate
STYLE: ReliaGear	RATING: Fully
BUS BRACING (RMS SYM)	100000 A
DEV. MIN. INT. RATING (RMS SYM)	100000 A
Total Line Up Width: 70	

**Feeders**

- 8 – XT4 250 A (dial down to 100 A)
- 2 – XT5 600 A (dial down to 240 A)
- 2 – XT4 Spaces (future expansion)

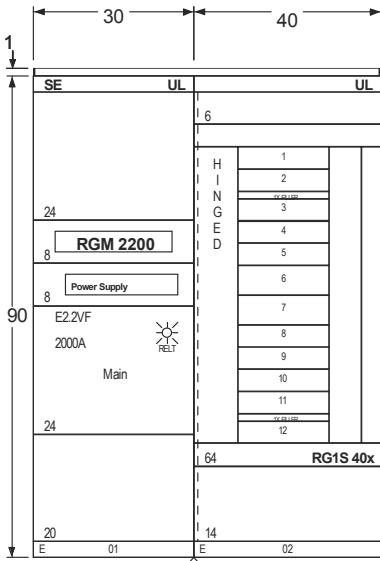

Front View

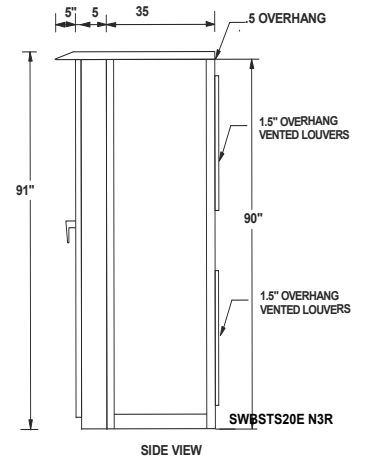
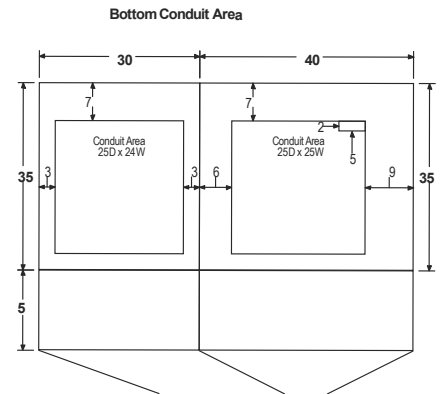
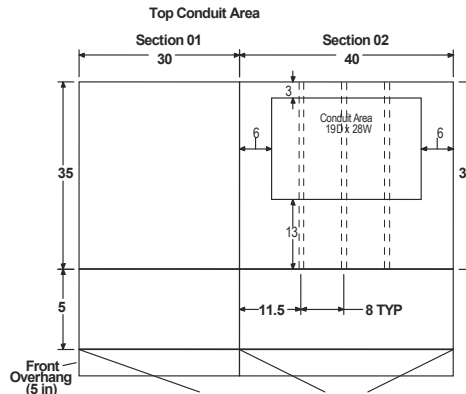

Switchboard/Device Information						
Circuit No.	Device	Amps	Poles	Nameplates	Lugs	Notes
Main	SH	2000	3			11, 12, 13, 14, 15
1	XT4L250	100	3	(Space and Bus)	AI (1) #4 - 300 MCM Cu Cbl	9
2	XT4L250	100	3	(Space and Bus)	AI (1) #4 - 300 MCM Cu Cbl	9
3	XT4L250	250	3		AI (1) 3/0 - 350 MCM Cu Cbl	8
4	XT4L250	250	3		AI (1) 3/0 - 350 MCM Cu Cbl	8
5	XT4L250	250	3		AI (1) 3/0 - 350 MCM Cu Cbl	8
6	XT5L600	600	3		AI (2) 2/0 - 500 MCM Cu Cbl	8
7	XT5L600	600	3		AI (2) 2/0 - 500 MCM Cu Cbl	8
8	XT4L250	250	3		AI (1) 3/0 - 350 MCM Cu Cbl	8
9	XT4L250	250	3		AI (1) 3/0 - 350 MCM Cu Cbl	8
10	XT4L250	250	3		AI (1) 3/0 - 350 MCM Cu Cbl	8
11	XT4L250	250	3		AI (1) 3/0 - 350 MCM Cu Cbl	8
12	XT4L250	250	3		AI (1) 3/0 - 350 MCM Cu Cbl	8

**NOTES:**

- Copper ground bus furnished.
- Equipment ground bus furnished with lugs.
- Switchboard furnished with Nameplates.
- Shipping splits between each section, ship each section separately.
- RGM 2200 Meter Modbus RS485 + Pulse installed in Switchboard. See drawing SWBSTS20EWD.
- Switchboard furnished with hinged gutter covers.
- Switchboard furnished with fully rated panel.
- Device furnished with EKIP DIP (LSI) programmer.
- Device furnished with TMA programmer.
- Provision For Future Extension.
- Device is furnished with 24V - 48V DC Ekip Supply.
- Device is furnished with 250V Bell Alarm.
- Device is furnished with RELT-Ekip Signalling 2K3 module. See drawing SWBSTS20EWD.
- Device furnished with 400V (4Q) Auxiliary Contacts.
- Device furnished with EKIP Touch LSIG trip unit.
- Equipment is furnished to work with 480/277 V and 208/120V. See drawing SWBSTS20EWD to select the operating voltage. Control circuit is unplugged, customer is responsible to connect the correct voltage source.
- Listed NEMA 3R rated Hub and Conduit should be used to maintain environmental integrity of the enclosure.
- Switchboard furnished with a rainproof TYPE 3R Flatroof (non walk-in) enclosure.

# ReliaGear® SB 4000 A — NEMA 3R

## Catalog# SWBSTS40EN3R (2-week cycle)

## SWBSTS40EN3R-M (10-week cycle)

ReliaGear® SB  
switchboard

ACCESS TO: Front Only	PHASE: 3P4W
CLASS: 2	AMPERE: 4000
LABEL:UL SE	BUS MTL:Cu 1000A / in <sup>2</sup>
VOLTAGE:480Y/277V	PLATE: Silver Plate
STYLE: ReliaGear	RATING: Fully
BUS BRACING (RMS SYM)	100000 A
DEV. MIN. INT. RATING (RMS SYM)	100000 A
Total Line Up Width: 90	

**Feeders**

- 3 – XT4 250 A (dial down to 100 A)
- 2 – XT5 600 A (dial down to 240 A)
- 2 – XT7 1200 A (dial down to 480 A)
- 5 – XT4 spaces (future expansion)

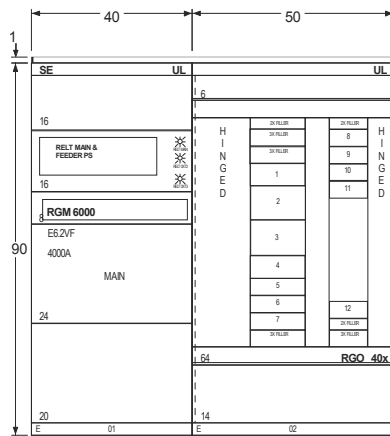

Front View

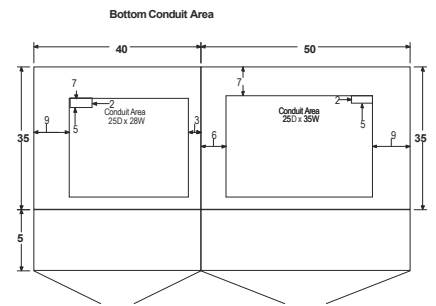
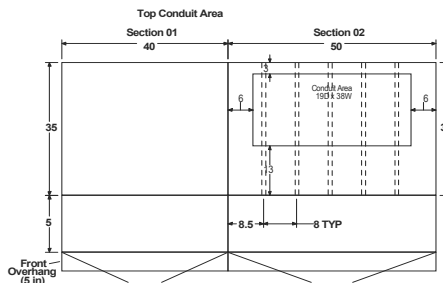

Switchboard/Device Information						
Circuit No.	Device	Amps	Poles	Nameplates	Lugs	Notes
1	E6.2VF	4000	3		AI (2) 2/0 - 500 MCM Cu Cbl	15,16,17,18,19,20,21
2	XT5L600	600	3		AI (4) 4/0 - 500 MCM Cu Cbl	8
3	XT7L1200	1200	3		AI (4) 4/0 - 500 MCM Cu Cbl	9,10,13,14
4	XT5L600	600	3		AI (2) 2/0 - 500 MCM Cu Cbl	8
5	XT4L250	100	3	(Space and Bus)	AI (1) #4 - 300 MCM Cu Cbl	11
6	XT4L250	100	3	(Space and Bus)	AI (1) #4 - 300 MCM Cu Cbl	11
7	XT4L250	250	3		AI (1) 3/0 - 350 MCM Cu Cbl	8
8	XT4L250	250	3		AI (1) 3/0 - 350 MCM Cu Cbl	8
9	XT4L250	250	3		AI (1) 3/0 - 350 MCM Cu Cbl	8
10	XT4L250	100	3	(Space and Bus)	AI (1) #4 - 300 MCM Cu Cbl	11
11	XT4L250	100	3	(Space and Bus)	AI (1) #4 - 300 MCM Cu Cbl	11
12	XT4L250	100	3	(Space and Bus)	AI (1) #4 - 300 MCM Cu Cbl	11

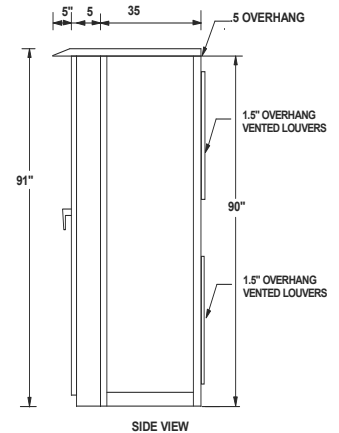

SIDE VIEW

**NOTES:**

- 1 Copper ground bus furnished.
- 2 Equipment ground bus furnished with lugs.
- 3 Switchboard furnished with Nameplates.
- 4 Shipping splits between each section, ship each section separately.
- 5 RGM6000 Meter installed in Switchboard. See drawing SWBSTS40EWD.
- 6 Switchboard furnished with hinged gutter covers.
- 7 Switchboard furnished with fully rated panel.
- 8 Device furnished with EKIP DIP (LSI) programmer.
- 9 Device furnished with EKIP Touch (LSIG) programmer.
- 10 Device furnished with RELT. See drawing SWBSTS40EWD.
- 11 Device furnished with TMA programmer.
- 12 Provision For Future Extension.
- 13 Device furnished with EKIP RELT Signalling.
- 14 Device furnished with EKIP 24VDC Supply.
- 15 Device is furnished with 24V - 48V DC Ekip Supply.
- 16 Device is furnished with 250V Bell Alarm.
- 17 Device is furnished with RELT-Ekip Signalling 2K3 module.
- 18 Device furnished with (PLC) Open Position - Padlock
- 19 Device furnished with 400V (4Q) Auxiliary Contacts.
- 20 Device furnished with EKIP Touch LSIG trip unit.
- 21 Device furnished with RELT. See drawing SWBSTS40EWD.
- 22 Equipment is furnished to work with 480/277 V and 208/120 V. See drawing SWBSTS40EWD to select the operating voltage. Control circuit is unplugged, customer is responsible to connect the correct voltage source.
- 23 Switchboard furnished with a rainproof TYPE 3R Flatroof (non walk-in) enclosure.
- 24 Listed NEMA 3R rated Hub and Conduit should be used to maintain environmental integrity of the enclosure.

# ReliaGear® SB 4000 A NEMA 3R add-on feeder section\*

Catalog# SWBSTS40EDISTN3R (2-week cycle)  
 SWBSTS40EDISTN3R-M (10-week cycle)

ReliaGear® SB  
switchboard

ACCESS TO: Front Only	PHASE: 3P4W
CLASS: 1	AMPERE: 4000
LABEL: U/L	BUS MTL: Cu 1000A / in <sup>2</sup>
VOLTAGE: 480Y/277V	PLATE: Silver Plate
STYLE: ReliaGear	RATING: Fully
BUS BRACING (RMS SYM)	100000 A
DEV. MIN. INT. RATING (RMS SYM)	100000 A
Total Line Up Width: 50	

**Feeders**

- 3 – XT4 250 A (dial down to 100 A)
- 2 – XT5 600 A (dial down to 240 A)
- 2 – XT7 1000 A (dial down to 400 A)
- 5 – XT4 spaces (future expansion)

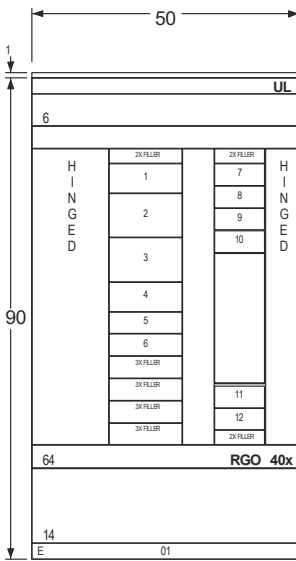

Front View

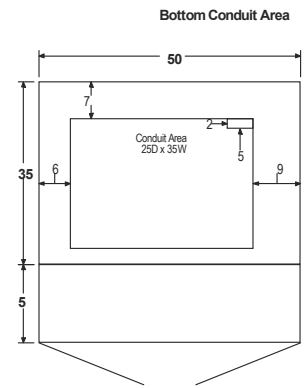
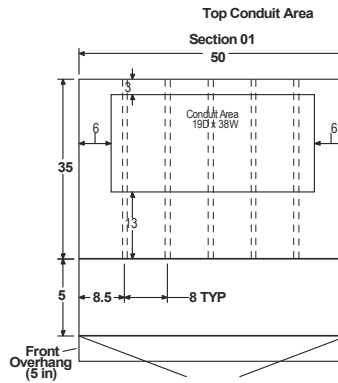

Front Overhang (5 in)

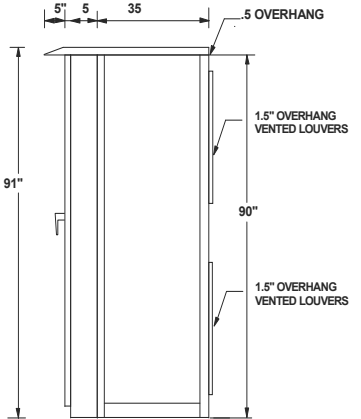

SIDE VIEW

Switchboard/Device Information

Circuit No.	Device	Amps	Poles	Nameplates	Lugs	Notes
1	XT5L600	600	3		Al (2) 2/0 - 500 MCM Cu Cbl	6
2	XT7L1000	1000	3		Al (4) 4/0 - 500 MCM Cu Cbl	9
3	XT7L1000	1000	3		Al (4) 4/0 - 500 MCM Cu Cbl	9
4	XT5L600	600	3		Al (2) 2/0 - 500 MCM Cu Cbl	6
5	XT4L250	100	3	(Space and Bus)	Al (1) #4 - 300 MCM Cu Cbl	7
6	XT4L250	100	3	(Space and Bus)	Al (1) #4 - 300 MCM Cu Cbl	7
7	XT4L250	250	3		Al (1) 3/0 - 350 MCM Cu Cbl	6
8	XT4L250	250	3		Al (1) 3/0 - 350 MCM Cu Cbl	6
9	XT4L250	250	3		Al (1) 3/0 - 350 MCM Cu Cbl	6
10	XT4L250	100	3	(Space and Bus)	Al (1) #4 - 300 MCM Cu Cbl	7
11	XT4L250	100	3	(Space and Bus)	Al (1) #4 - 300 MCM Cu Cbl	7
12	XT4L250	100	3	(Space and Bus)	Al (1) #4 - 300 MCM Cu Cbl	7

NOTES:

- 1 Copper ground bus furnished.
- 2 Equipment ground bus furnished with lugs.
- 3 Switchboard furnished with Nameplates.
- 4 Switchboard furnished with hinged gutter covers.
- 5 Switchboard furnished with fully rated panel.
- 6 Device furnished with EKIP DIP (LSI) programmer.
- 7 Device furnished with TMA programmer.
- 8 Provision For Future Extension.
- 9 Device furnished with EKIP DIP (LSIG) programmer.
- 10 Switchboard furnished with a rainproof Type 3R Flatroof (non walk-in) enclosure.
- 11 Listed NEMA 3R rated hub and conduit should be used to maintain environmental integrity of the enclosure

\*Applied only as an "add-on" section to SWBSTS40EN3R or SWBSTS40EN3R-M.







—

**ABB Inc.**

305 Gregson Drive  
Cary, NC 27511 USA

**[abb.com/contacts](http://abb.com/contacts)**  
**[abb.com/lowvoltage](http://abb.com/lowvoltage)**

—

We reserve the right to make technical changes or modify the contents of this document without prior notice. With regard to purchase orders, the agreed particulars shall prevail. ABB Inc. does not accept any responsibility whatsoever for potential errors or possible lack of information in this document.

We reserve all rights in this document and in the subject matter and illustrations contained therein. Any reproduction, disclosure to third parties or utilization of its contents – in whole or in parts – is forbidden without prior written consent of ABB Inc. Copyright© 2023 ABB  
All rights reserved