



# RESIDENTIAL SMART LIGHTING SIMPLIFIED

---

SCHAEDLER YESCO EXPO 2024

 **legrand**<sup>®</sup>

# Agenda

---



01

**Market**

02

**Product Overview**

03

**Project Planning**

04

**Getting to know the devices**

05

**Installation**



# MARKET

adorned and radiant with Netatmo Wiring Devices



# Smart is a Key Part of Residential Lighting Controls



**85.6M U.S. HH** (or 70%)  
own at least 1 smart home device.

73.2M, **60% plan to buy**  
smart products in next 12 months.

Prospective buyers HH plan to  
**add an average of 8**  
different types of smart products.

**Consumer motivators:**  
convenience and safety/security.  
+

95M Smart Speakers installed with  
73%+ using daily or more.

# Homeowners Want Home Tech: **What** and **Where**

## Top PRODUCTS

- Tech Champions
- Passionate Smart Homers
- Aspiring Smart Homers
- Status Quo Tech Owners
- Unmotivated Tech Owners

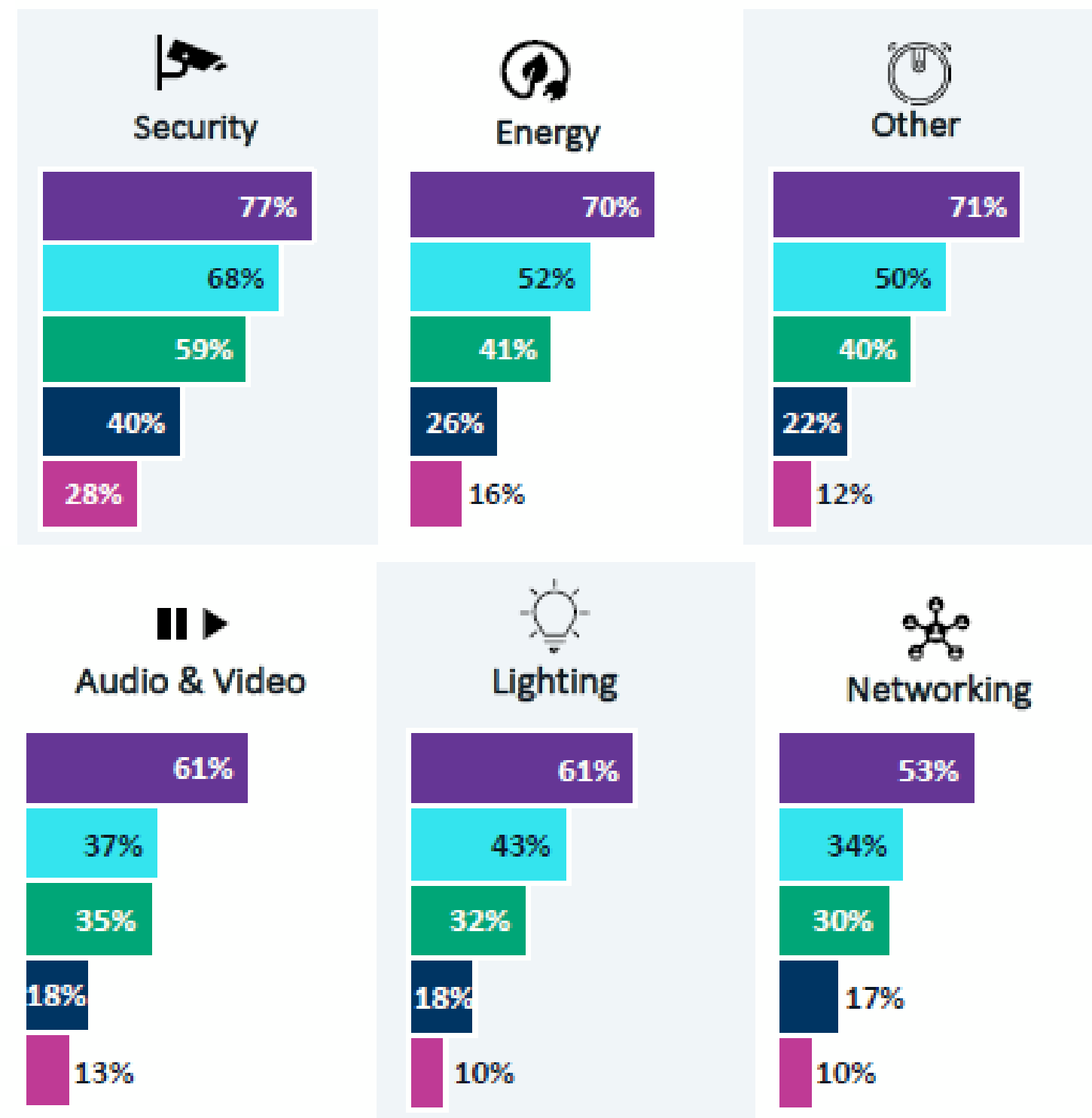

## Top SPACES

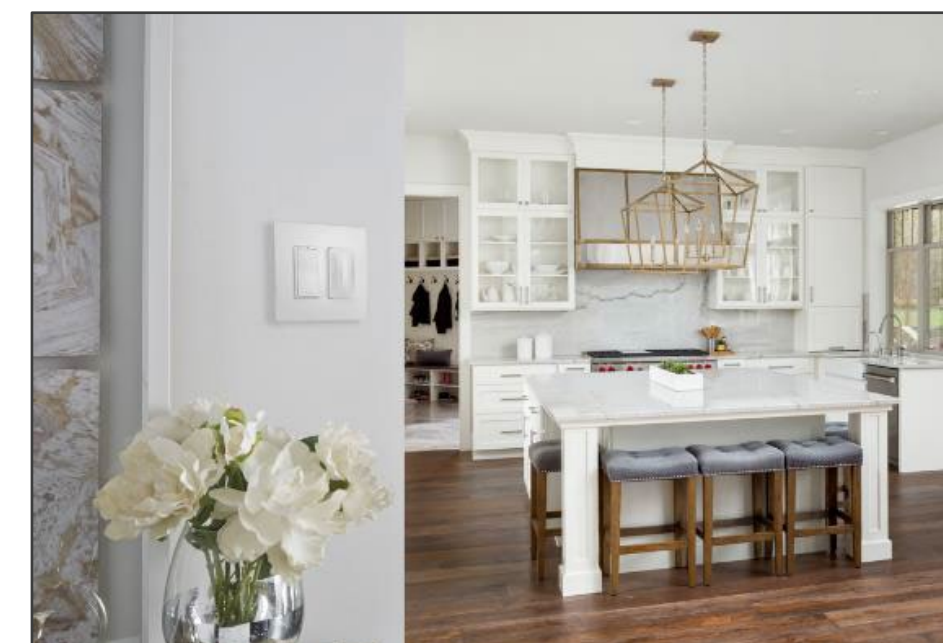

Kitchen



Outdoors



Bedroom



Living Room

. \*CTA. "Exploring the Smart Home Ecosystem in 2022. May 2022.

# PLATFORM OVERVIEW

adorned and radiant with Netatmo Wiring Devices



# Smart is in Everything We Do.

We design smart into a **new age of electrical devices.**  
Why add more products? Enable the devices that are already there

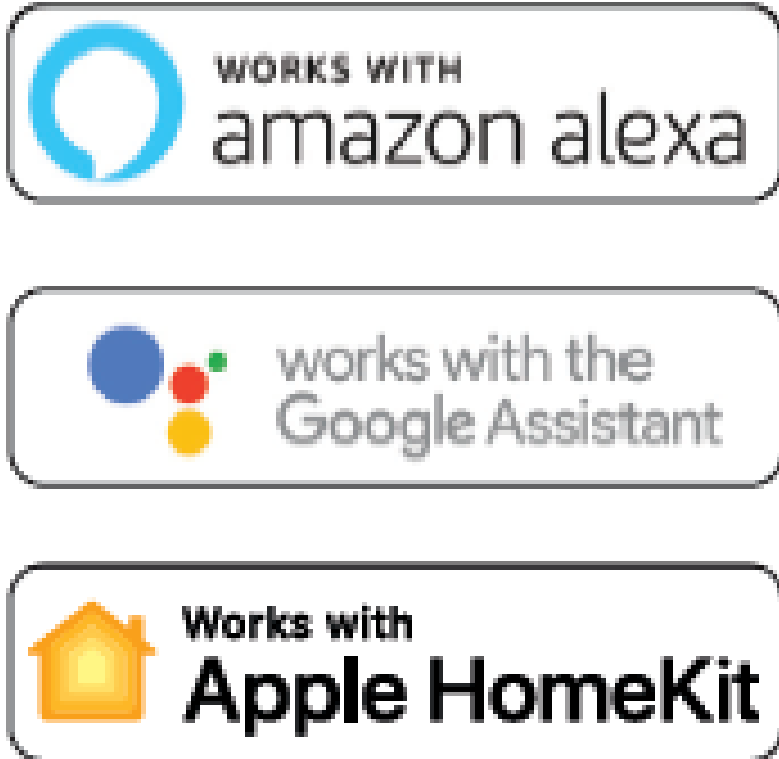

## Built-In Smart

Same quality devices you know and trust. Simple design that matches every other switch & outlet.

## Homeowner Chooses Control Platform

Homeowners already have a control platform that they're comfortable with and compatible devices.

## Integration 100,000\* Smart Devices

Through Alexa, Google, and Homekit you can integrate over 100,000 smart products..

A PERFECT  
SMART LIGHTING SOLUTION  
FOR EVERY HOME.

## Smart Lighting Control: A Solution For Every Home

TO TAKE CONTROL OF THE WHOLE HOME

radiant® WITH Netatmo



adorne® WITH Netatmo



The smartest way to take control of lights and power, optimized for an ultra-reliable whole home experience.

- ✓ Mesh network:
  - Works where Wi-Fi is weak
  - Lights always controllable at switch
  - Even if Wi-Fi is out, scenes & schedules active
  - Expands to whole home (100 devices)
- ✓ Wireless, battery-operated devices
- ✓ Energy Monitoring & Management
- ✓ Match every device, smart or not:
  - Aesthetically pleasing smart devices are available in adorne® and radiant® collections
- ✓ Automatic Updates



Manage lights and power, from anywhere, with the Legrand Home + Control app.



\*HomeKit only works with adorne and radiant with Netatmo



# Meet *Traditional* Lighting Control Needs

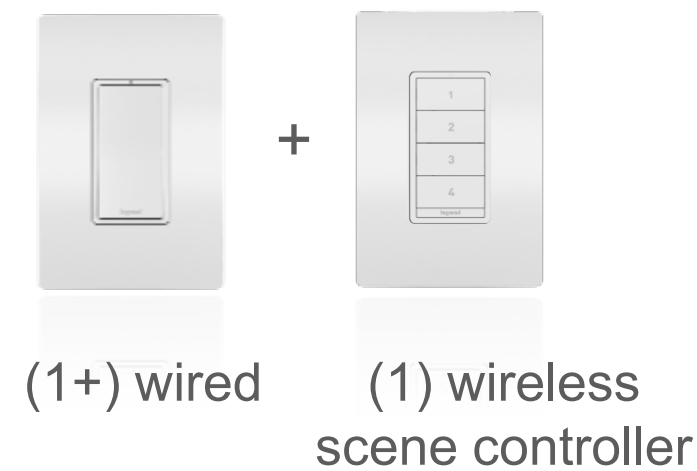
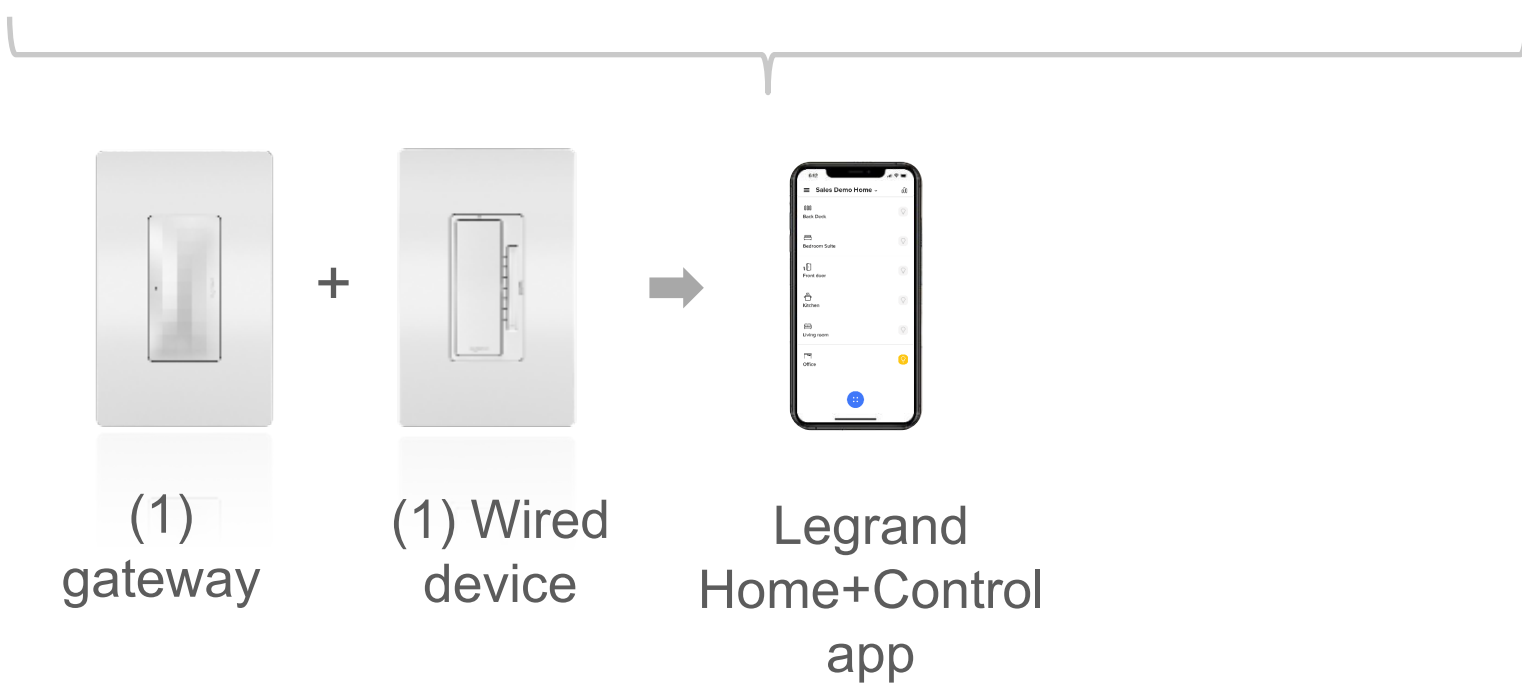
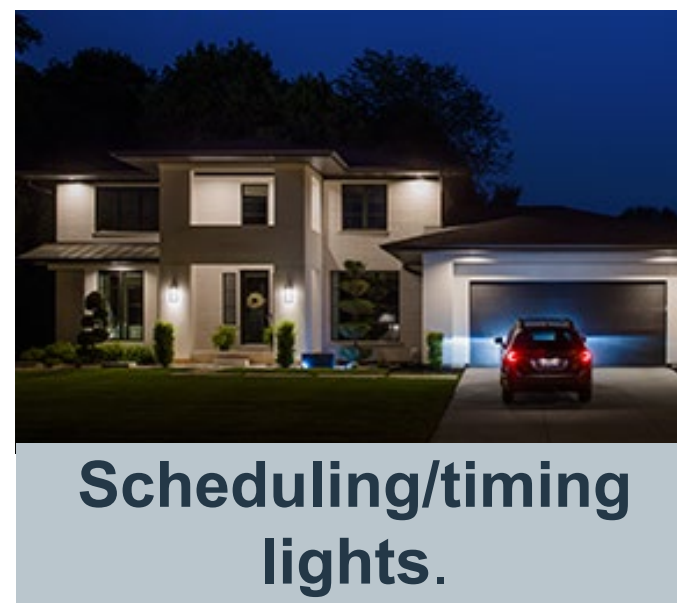
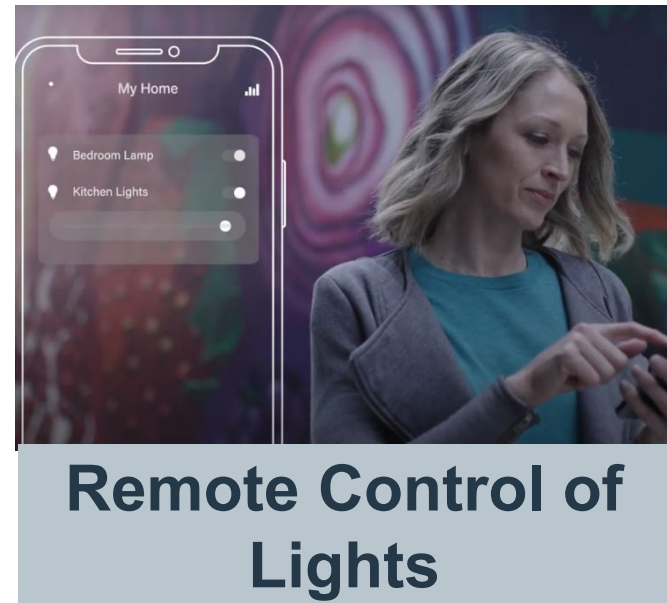
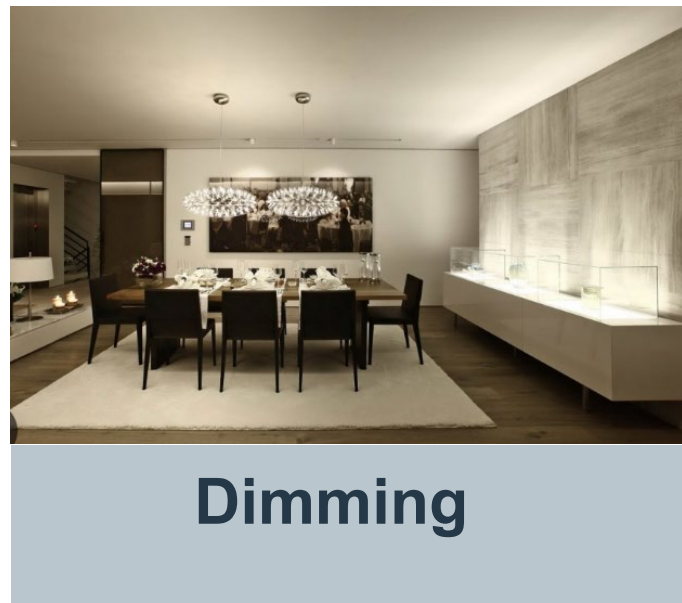

## One Platform Multi-functional devices

- ✓ Enhanced dimming
- ✓ Astronomical timer
- ✓ Remote access
- ✓ Scene creation

Tru-Universal – self calibrates AND Auto Updates



designed to be better.

# Plus, Meet *More Project* Needs:



Difficult or No Wiring



Add a Switch



Minimize clutter.

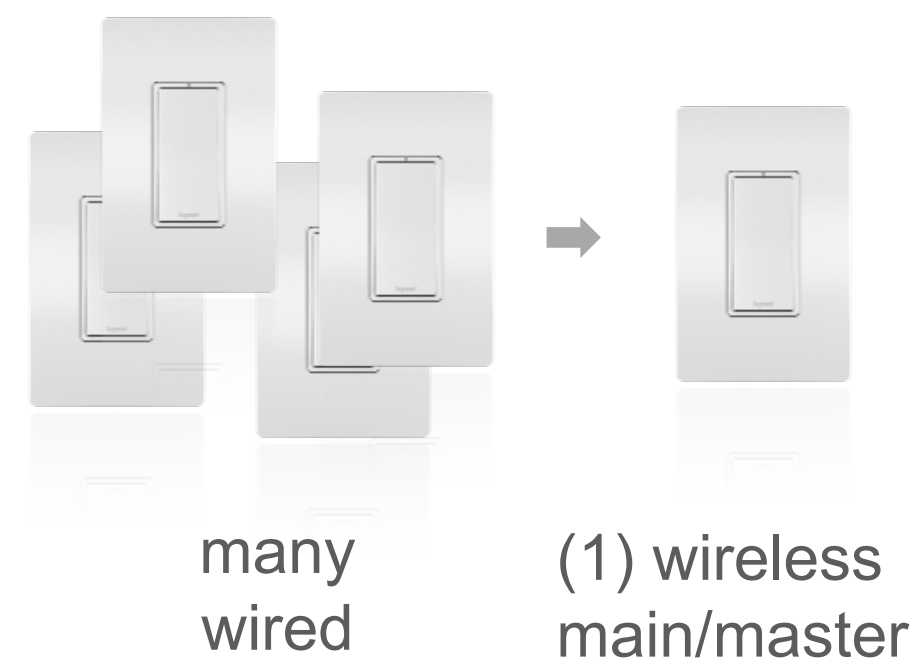
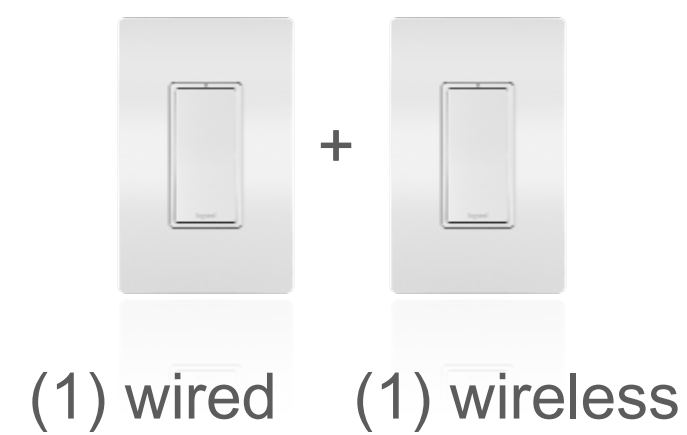

## Productivity

- ✓ Reduce wire runs (cost & labor)
- ✓ Speed up rough in
- ✓ Win more service jobs

## Project Design & Finish

- ✓ radiant and adorne collections
- ✓ Matching devices
- ✓ Minimized wall clutter

# Plus, Meet *Today's* Customer Needs: Safety & Energy Efficiency

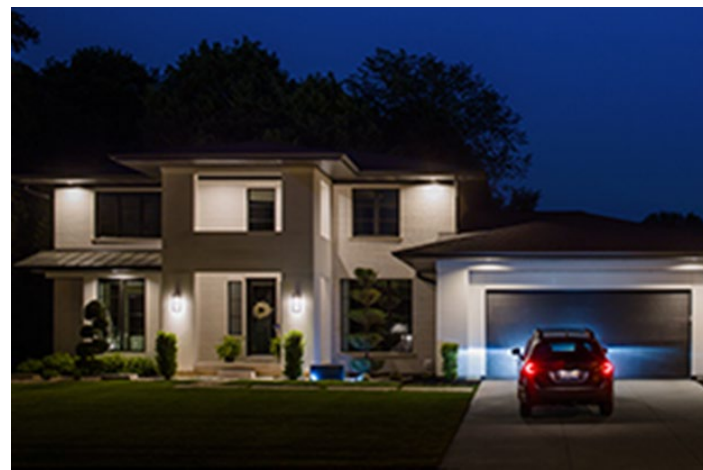

Lights Entering Home.



Peace of Mind.



Lights left on / Energy Visibility.



Alerts: Power Failures

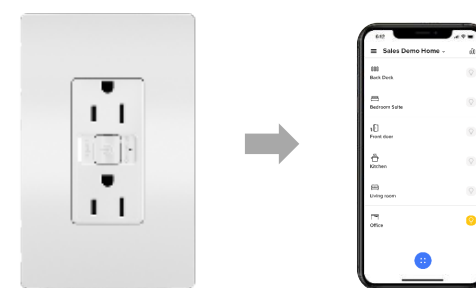

## Safety & Security

- ✓ Always lit home
- ✓ Geofence (via Alexa/Google/Homekit) for arrival lighting
- ✓ Never worried appliances were left on

## Energy Efficiency

- ✓ Customer expectation
- ✓ Meet code requirements
- ✓ Consumption data
- ✓ Save on energy bills

# GETTING TO KNOW THE DEVICES

adorned and radiant with Netatmo Wiring Devices



# BUILDING YOUR PERFECT SYSTEM

**COLORS:**

The radiant® Collection offers three device colors with matching wall plates included		The adorne® Collection offers three device colors and over 30 wall plate color and finish options	
	WHITE (WH)		WHITE (W)
	LIGHT ALMOND (LA)		MAGNESIUM (M)
	NICKEL (NI)		GRAPHITE (G)

## 1) SELECT YOUR GATEWAY

## 2) SELECT YOUR WIRED OR PLUG-IN DEVICES

## 3) SELECT YOUR WIRELESS DEVICES



### Smart In-Wall Gateway

Installs in a box in place of a switch or outlet to create a robust, dedicated network.

**CHOOSE ONE**

### Smart Surface-Mount Gateway

Installs beside a single-gang switch or outlet, no back box or network wiring required.



Smart Switch

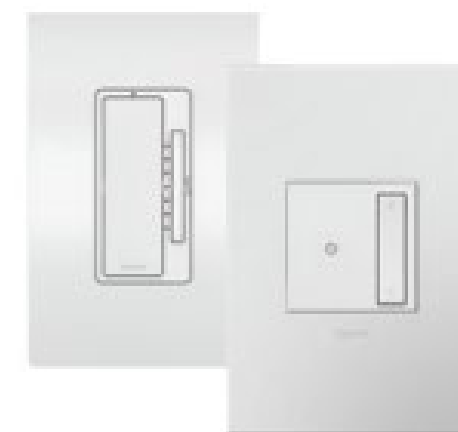

Smart Tru-Universal Dimmer



Wireless Smart Switch and Wireless Smart Dimmer



Home/Away Wireless Smart Switch and Wake/Sleep Wireless Smart Switch

↑ Add wireless switches/dimmers for 3 way or multi-location. ↑



Smart 15A and 20A Outlets



Smart Plug-In Switch and Smart Plug-In Tru-Universal Dimmer



Wireless Smart Scene Controller



Wireless Motion Sensor

Any combination up to 98 devices

# How the system works

- ✓ Zigbee based, robust mesh network
- ✓ Works even where Wi-Fi can't
- ✓ Gets stronger as you expand devices

- 1 Start with a gateway.
- 2 Add in-wall and plug-in dimmers/switches.
- 3 Add wireless switches for 3 way or scene control.
- 4 Control from the Legrand Home + Control app.

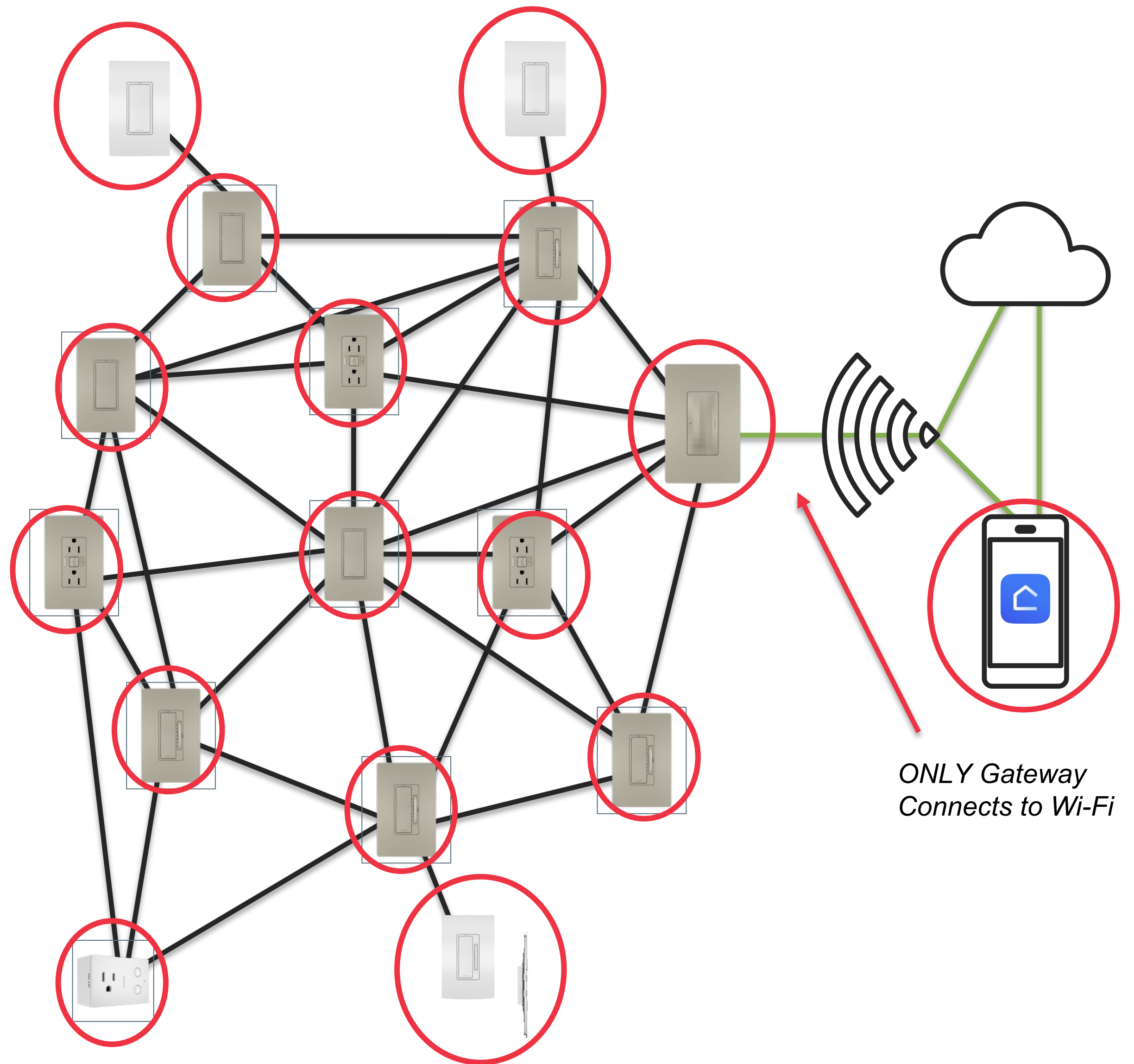

# Smart Gateway (In-wall)



## EZ Button:

**1.) Setup: Press & release opens the network to connect devices**



## EZ Button:

**2) Reset: Press hold 20 seconds resets to factory settings**

Sets up the mesh network.

# Smart Gateway (Surface Mount)

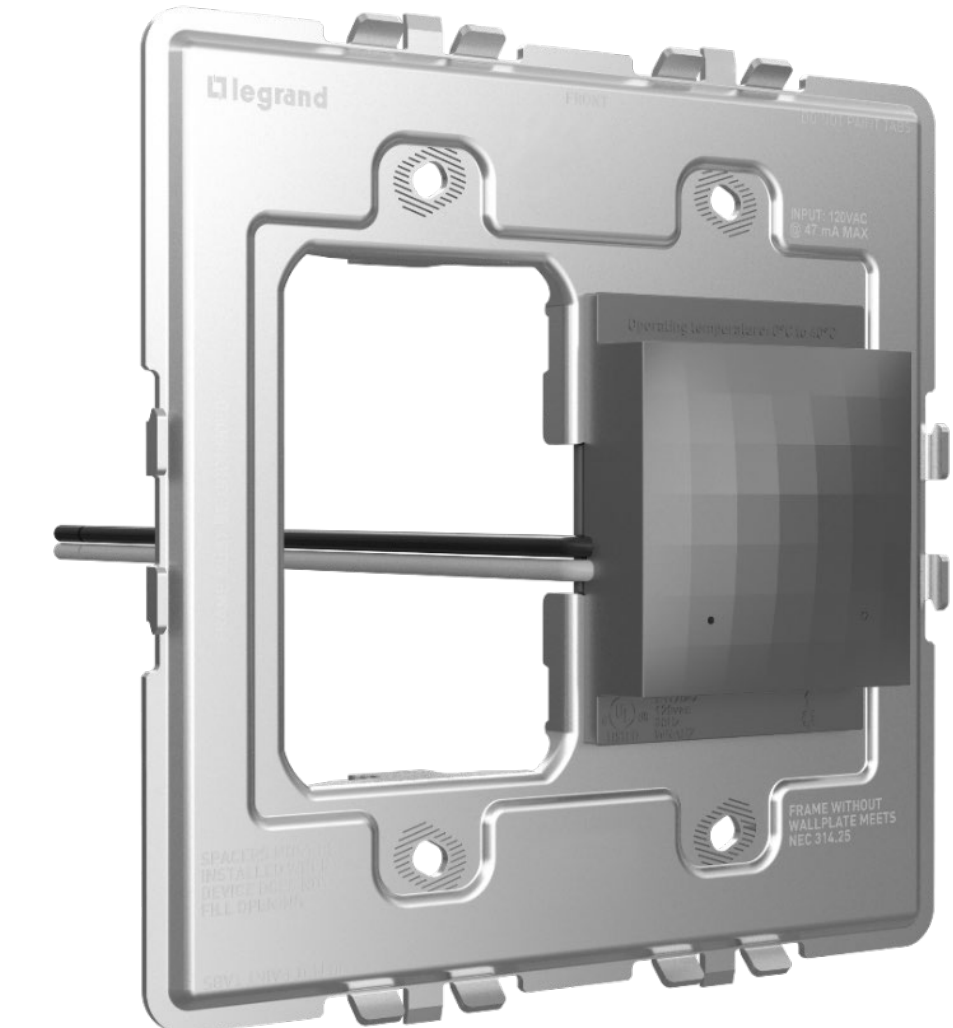
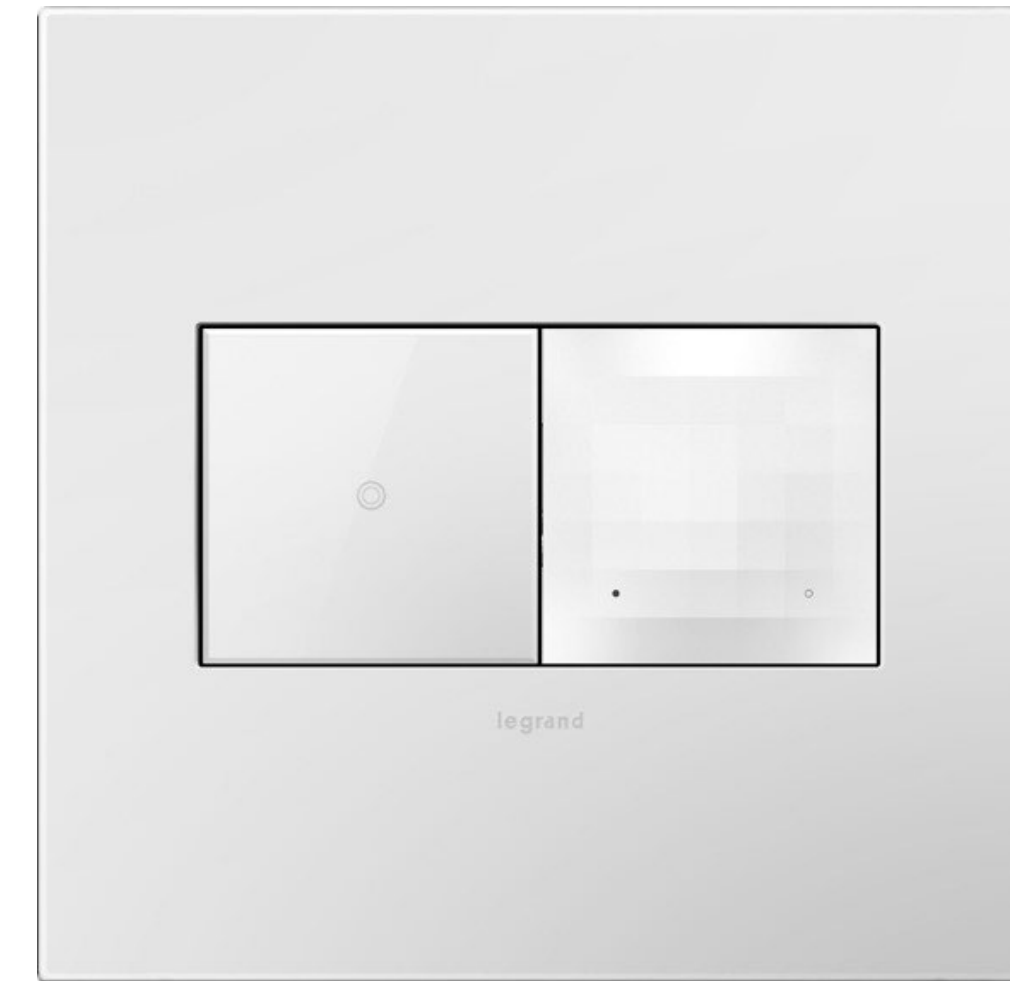

Flexible on-wall option sits adjacent to existing switch or outlet.



# adorne® and radiant® Smart Switch & Smart Tru-Universal Dimmer

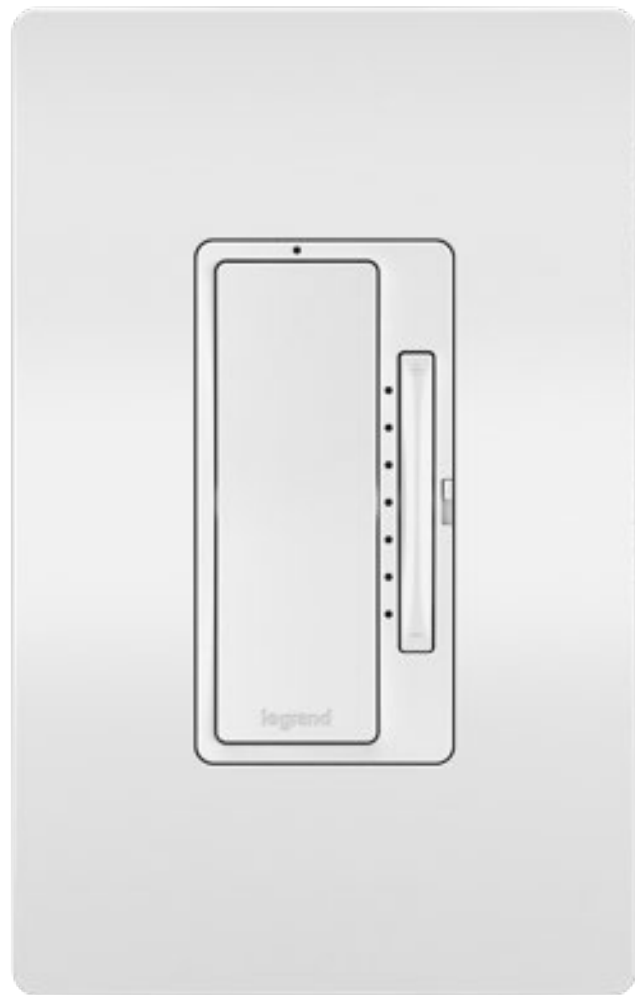
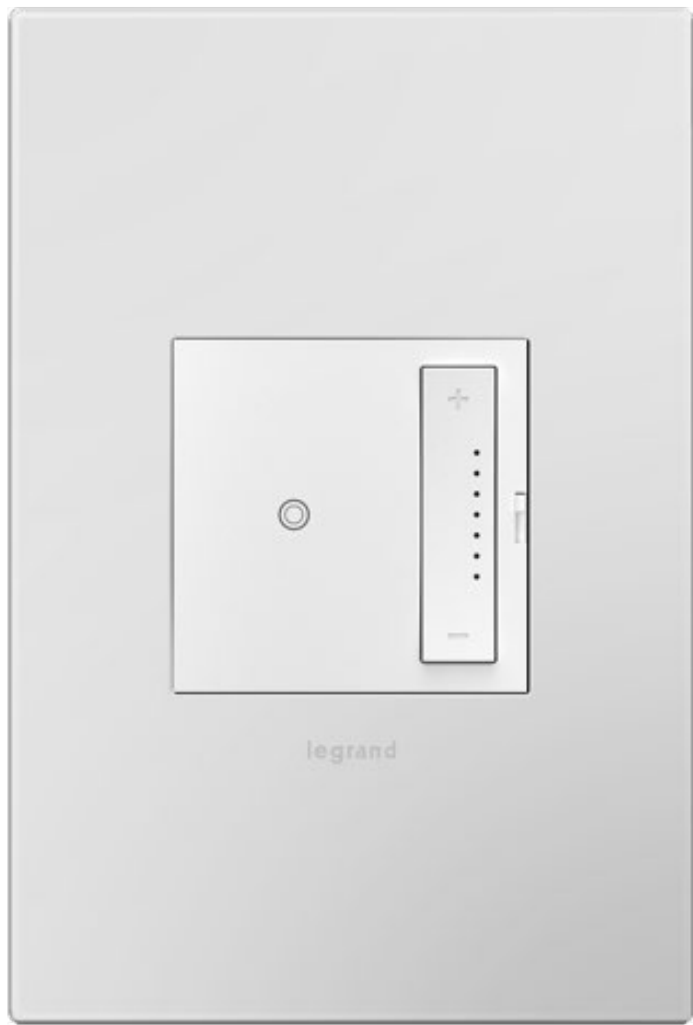
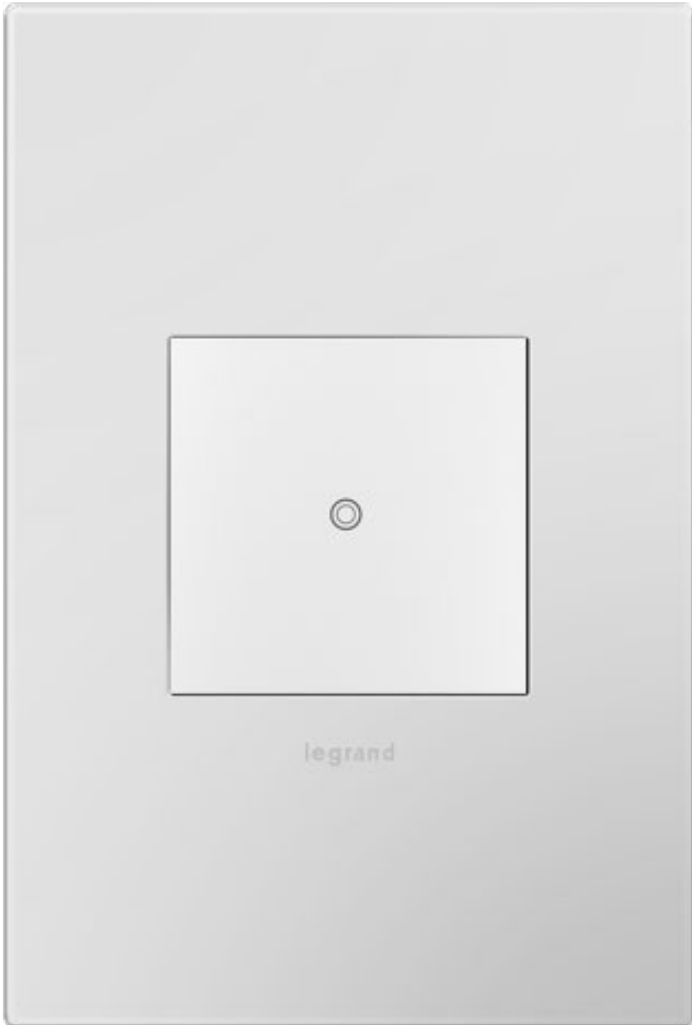

# adore<sup>®</sup> and radiant<sup>®</sup> Smart Outlets, 15A and 20A

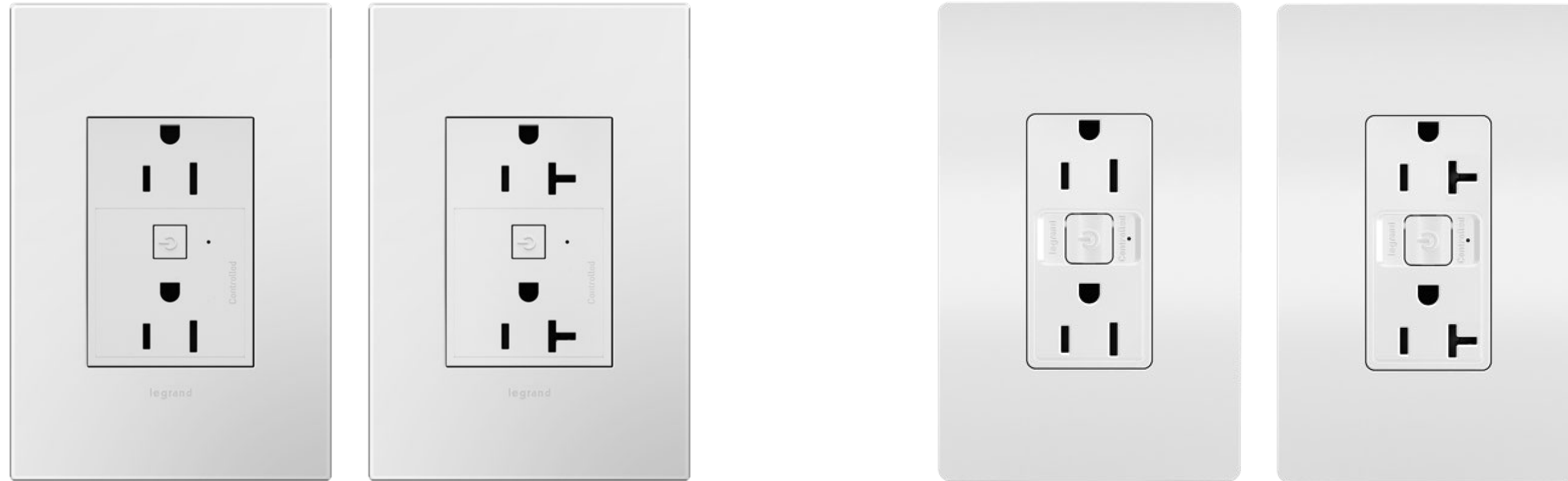

One outlet always on and one controlled  
OR wire for downstream control.

# adorne® and radiant® Wireless Smart Switch and Dimmer

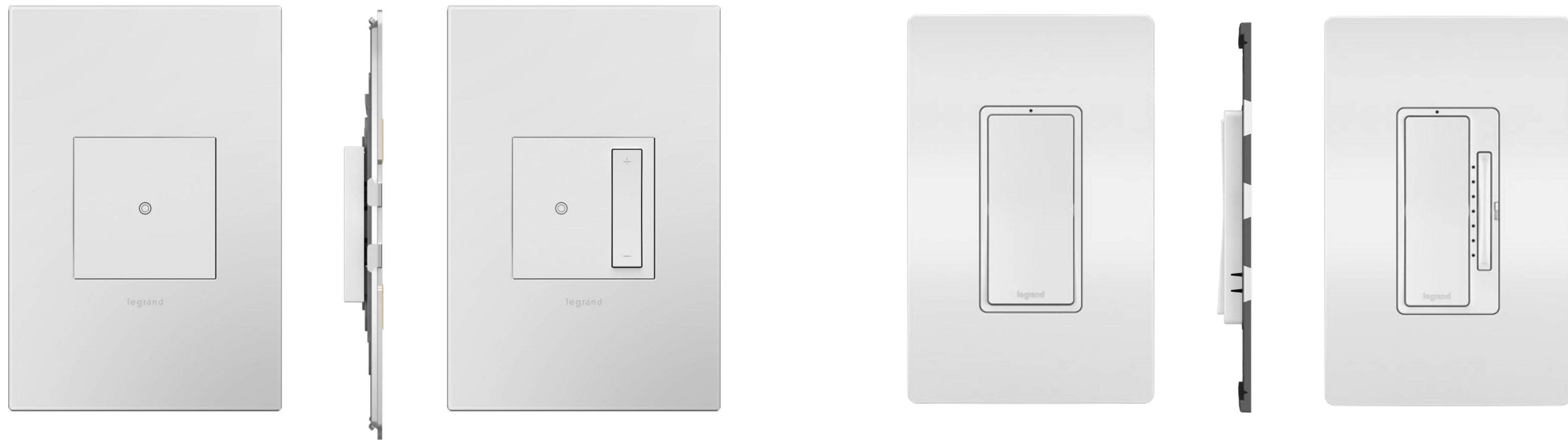

Add 3 Way Control – No Wires Needed.



# Wireless Battery Devices - Stick them anywhere!

---



# Battery device installation

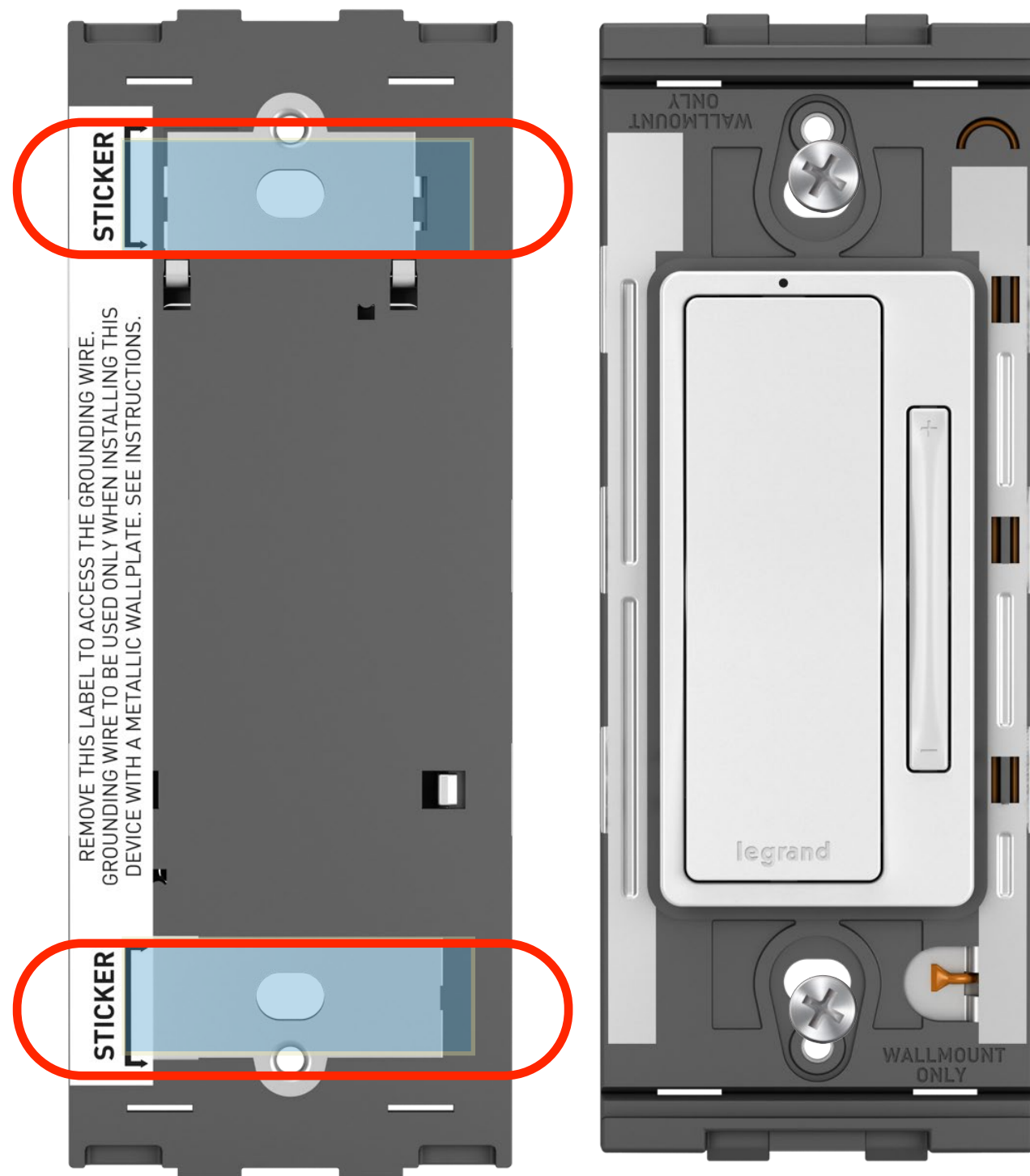

**1** Stick it to the wall OR Screw it on the wall

*Double Sided tape method not recommended for adorne real materials*



**2** Mount on an existing wall box

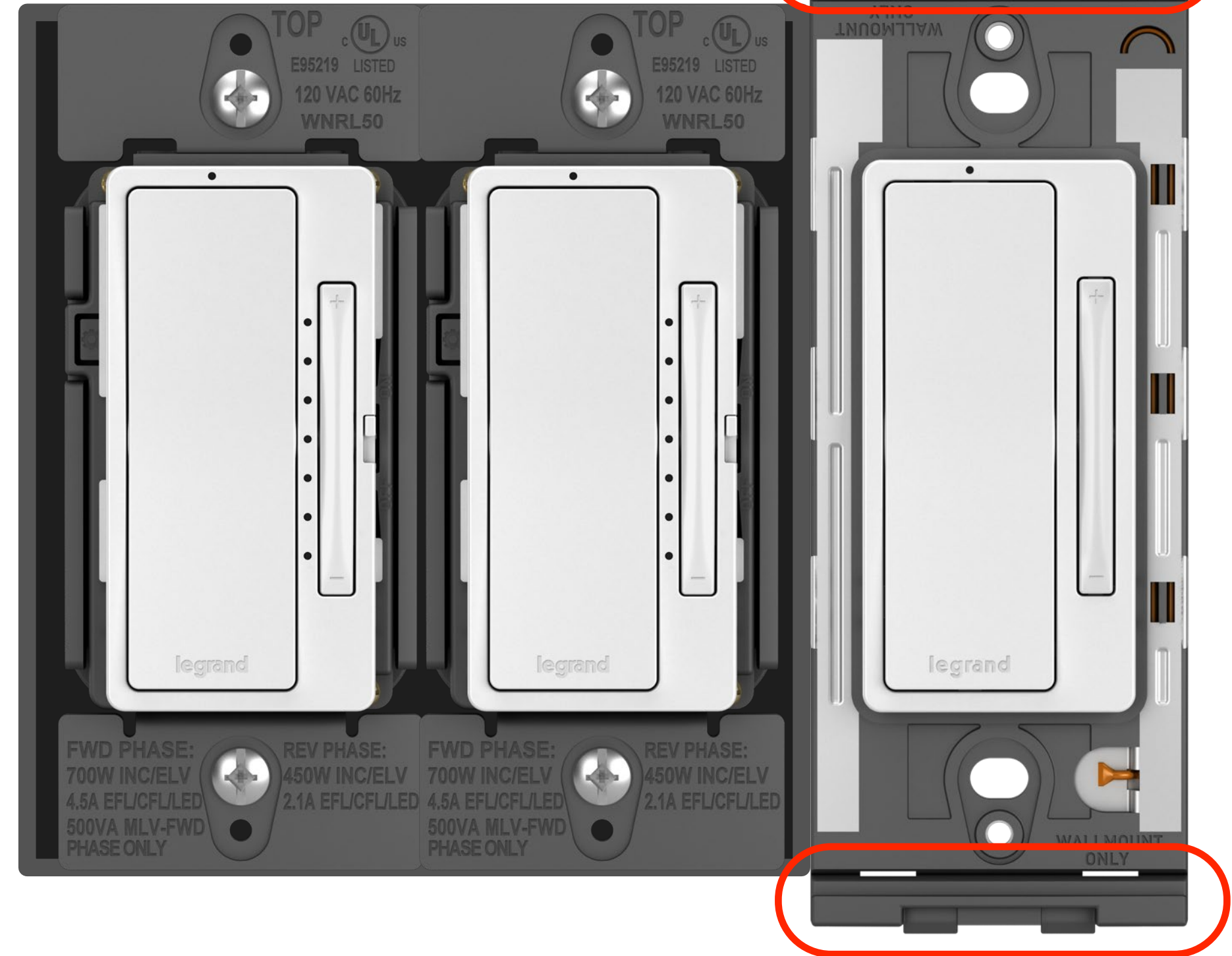

**3** Mount next to existing devices

Remove tab

Remove tab

3 Ways to mount.

# Wireless Smart Scene Controller



- Used to control 4 of 8 total scenes in app.
- Multiple scene controllers will map to same 4 scenes.



Press gateway EZ button then press any button to activate.

One button control of 4 personalized scenes.

# Home/Away & Wake/Sleep Wireless Smart Switch

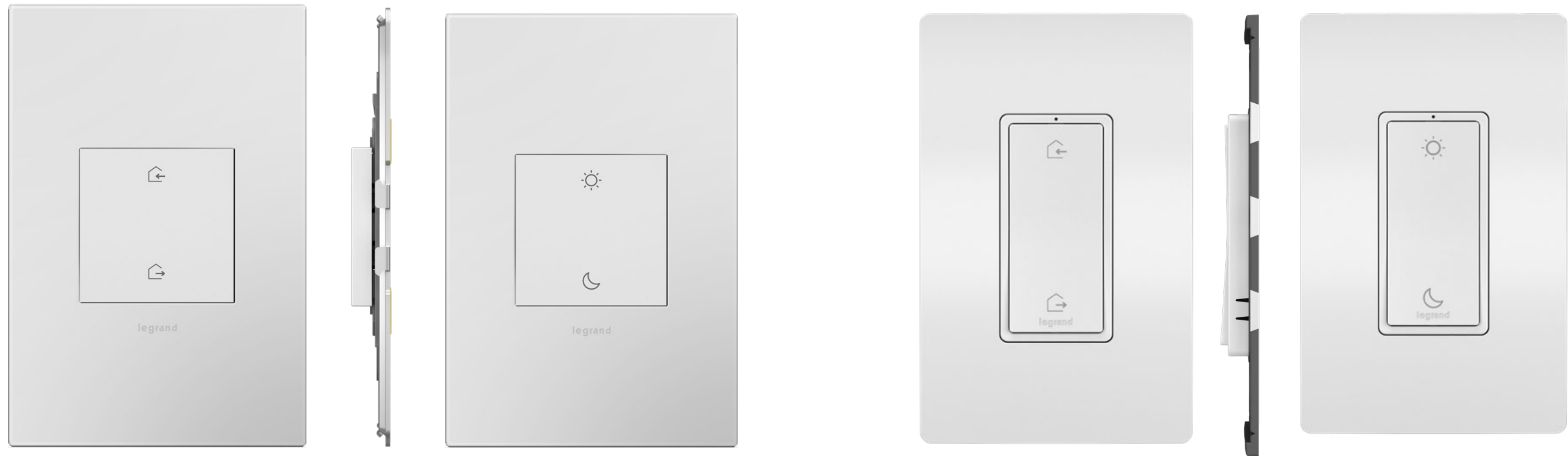

One button home control.

# Smart Plug-In Switch and Dimmer



WNP10

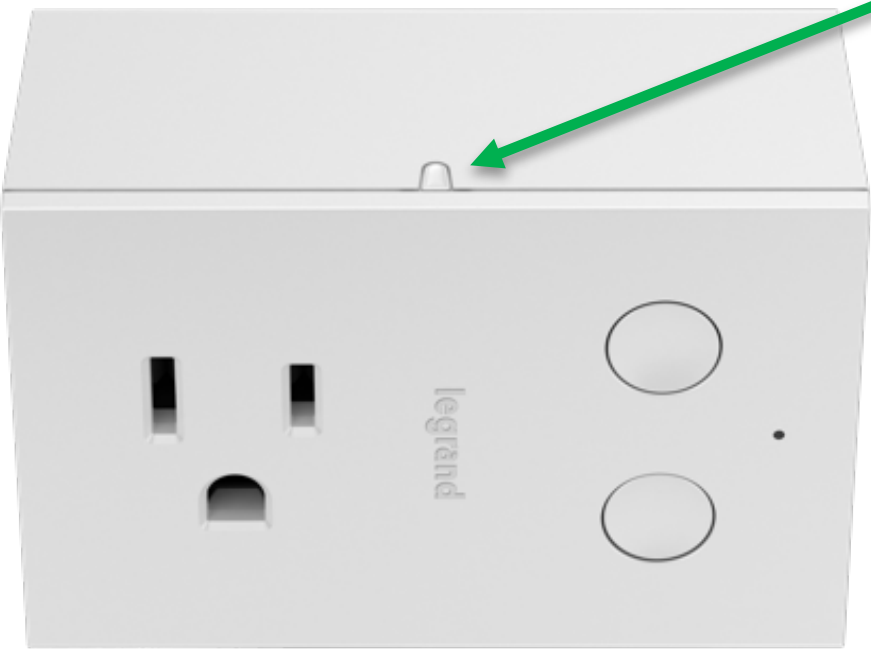

WNP20



# Smart Motion Sensor



Wirelessly mounts  
indoor/outdoor walls

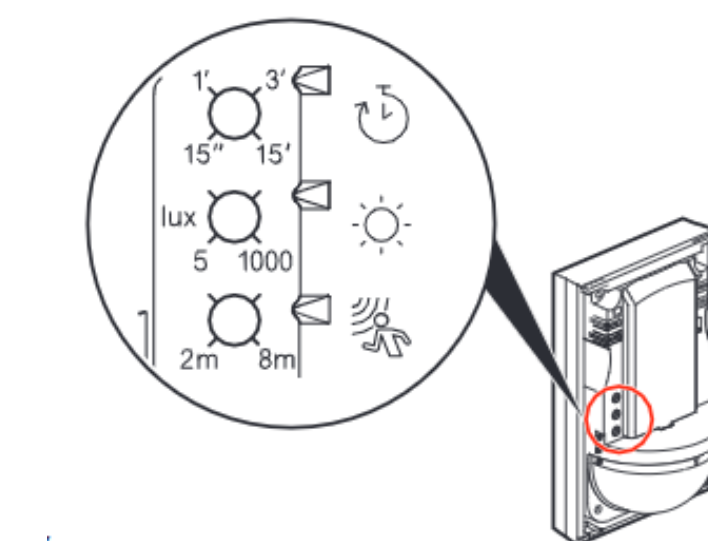
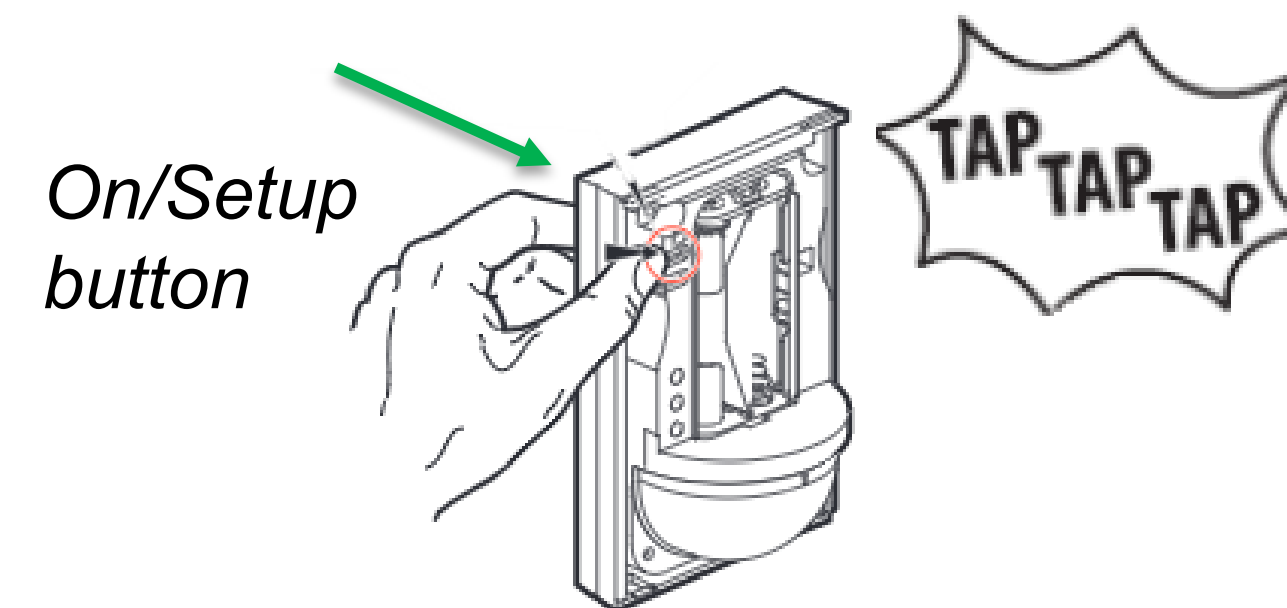

Adjust:

- time delay
- light sensitivity
- distance

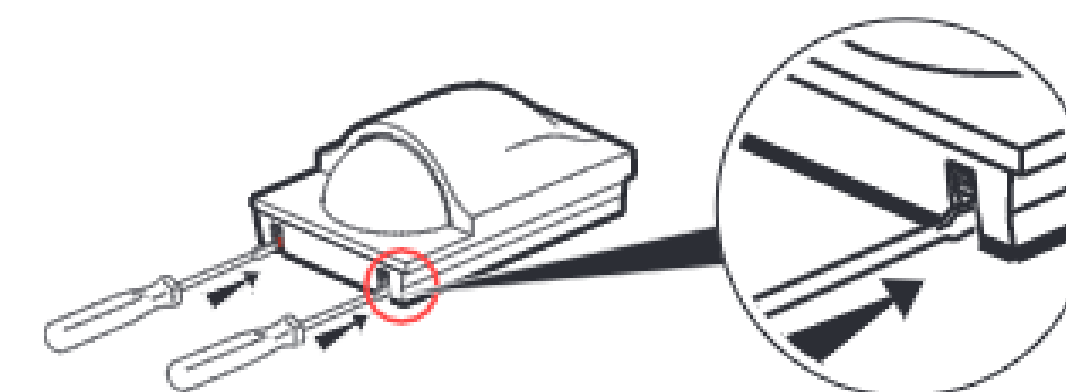

Breakoff tabs  
for outdoor use

Control up to 20 loads.

# SYSTEM INSTALLATION

adorned and radiant with Netatmo Wiring Devices



## 2 Onboarding Methods:

### 1 ONLINE

Using the app:

- ✓ connect the gateway to a Wi-Fi network
- ✓ connect devices to the gateway
- ✓ customize the system

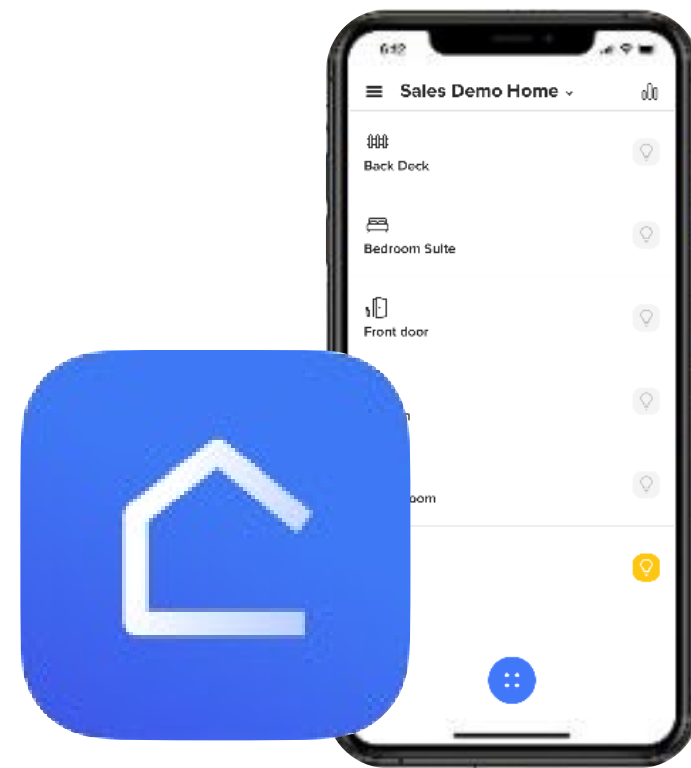

### 2 OFFLINE

From the devices:

- ✓ Connect devices to the gateway
- ✓ Pair 3-way switches/dimmers to load switches/dimmers

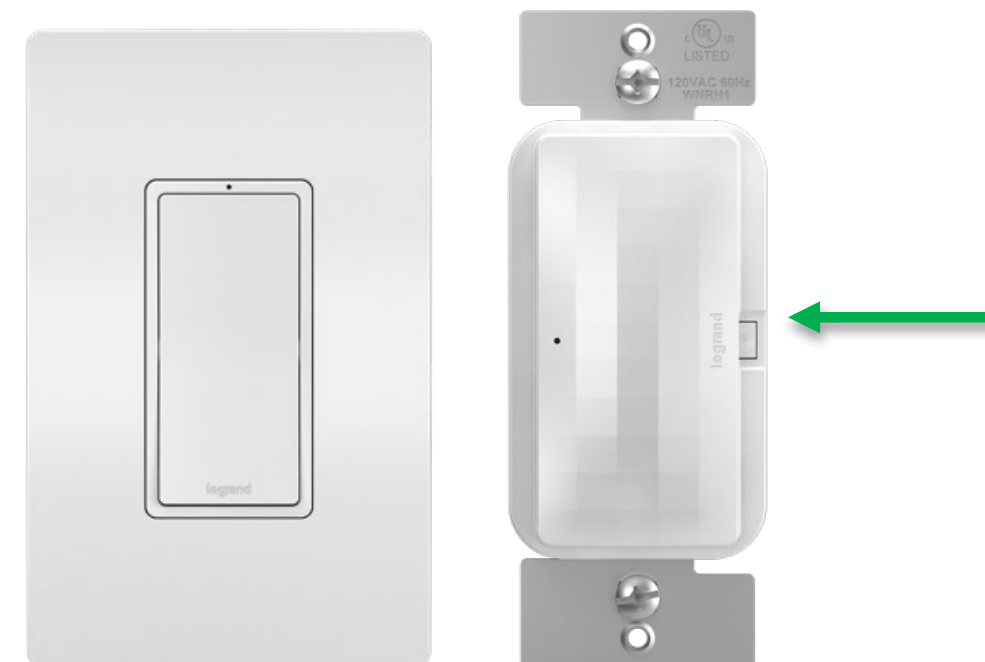

# Installation Process



↑  
*One time only.*

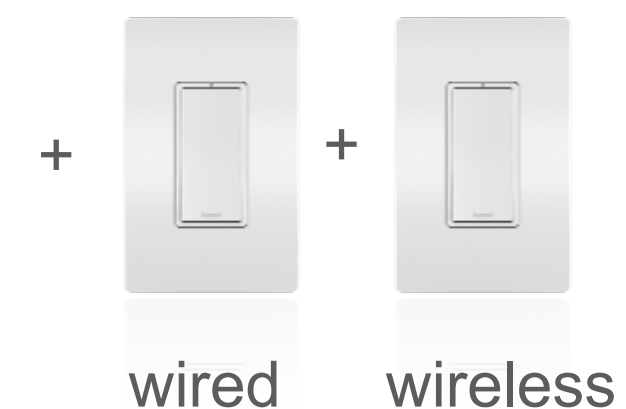

- ✓ Schedule Lights
- ✓ Personalize Scenes
- ✓ Setup Energy
- ✓ Adjust device settings

# System Requirements

## NETWORK

- 2.4 GHz connection (strong signal)
- No LANs or commercial networks
- Mobile device on same network as gateway
- Homekit – home data cleared and enabled

## GATEWAY

- 1 Gateway
- Good Wi-fi signal
- Always hot & neutral

## DEVICES

- Legrand Home + Control app
- 1+ wired devices (or plug in)
- 30 ft. or less between devices
- Neutral wires
- Wireless devices for multi-location control.

# Do's and Don'ts

---

## DOs

- Name devices & move to rooms as you onboard
- 1<sup>st</sup> add Wired devices, then wireless
- Check LED colors (green is onboard)
- Check “Unplaced Products”
- Call Tech support if you need help

## DON'Ts

- Pull battery tabs until ready to onboard
- Put the wall plates on before setup
- Cut power (or network) while onboarding
- Jump the gun on resetting
  - Resetting is a last resort

# Creating Your Legrand Account

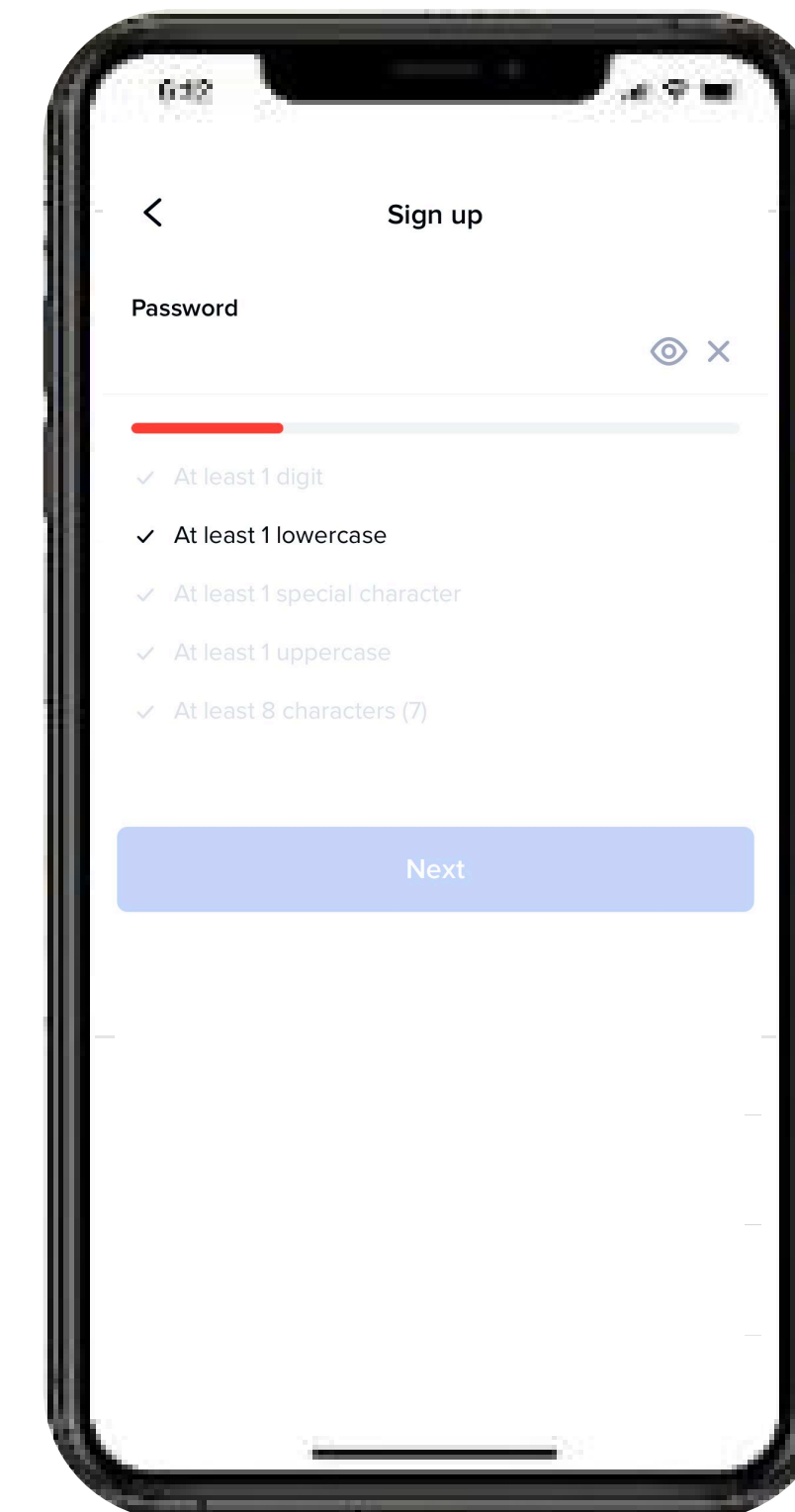
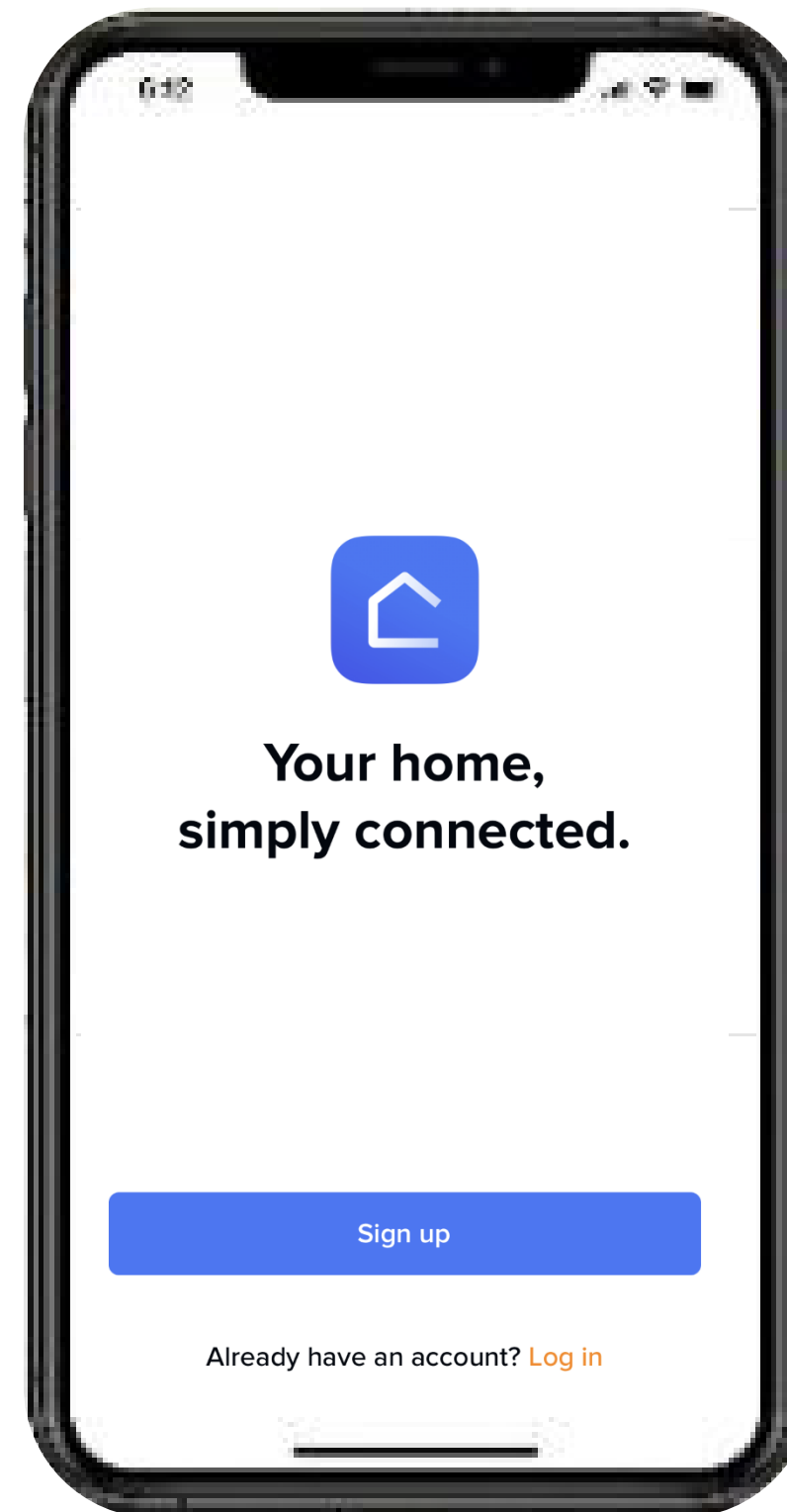

**1.)** Download

Legrand Home + Control app

**2.)** Open app

**3.)** Create an account

# EASY KITS

adorned and radiant with Netatmo Wiring Devices





# NO NEW WIRES; NO GATEWAY:

## Meet the radiant® with Netatmo Easy Kits

Can be expanded for 4-way control (or more) by adding more wireless devices. Or, go ahead and add a Gateway to upgrade these kits for app control and other smart features. Visit [legrand.us/addappcontrol](https://www.legrand.us/addappcontrol) to learn more.

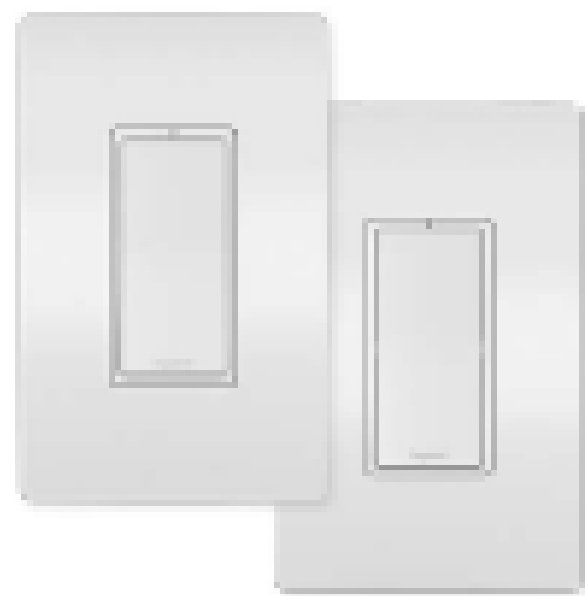

### Easy 3-Way Switch Kit

Add a wireless switch for control of a light or fixture from a second on-wall location.

Ideal for locations where you want to add another switch.



### Easy 3-Way Dimmer Kit

Add a wireless dimmer for light-level control of a light or fixture from a second on-wall location.

Ideal for locations where you want to add another dimmer.



### Easy Switched Outlet Kit

Add a wireless switch for on-wall control of a lamp or other plugged-in appliance.

Ideal for locations where you want to control a lamp from a switch.

# 3 *NEW* Easy Kits

No Gateway Required

	Product Name	Description	Part Number
	radiant Easy 3-Way Switch Kit	(1) WNRL10WH Smart Switch (1) WNRL23WH Smart Wireless Switch	WNREZK10WH
	radiant Easy 3-Way Dimmer Kit	(1) WNRL50WH Smart Dimmer (1) WNRL63WH Smart Wireless TU Dimmer	WNREZK50WH
	radiant Easy Switched Outlet Kit	(1) WNRR15WH Smart 15A Outlet (1) WNRL23WH Smart Wireless Switch	WNREZK15WH

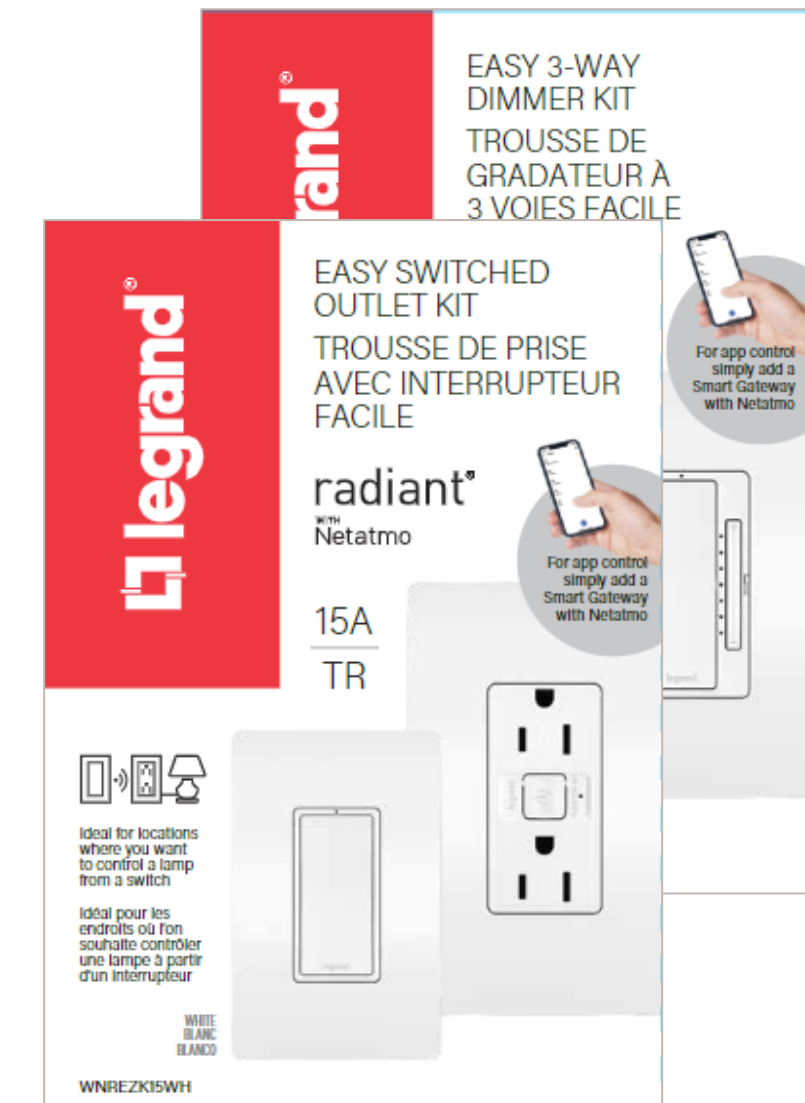

*radiant only. White only.*

## Without Gateway:

- NO APP CONTROL: remote control, schedules, scenes, alerts, no updates, no device settings control (such as reverse phase)
- NO INTEGRATION: Alexa, Google, Homekit



# Easy Kits: Installation (Ready to install)

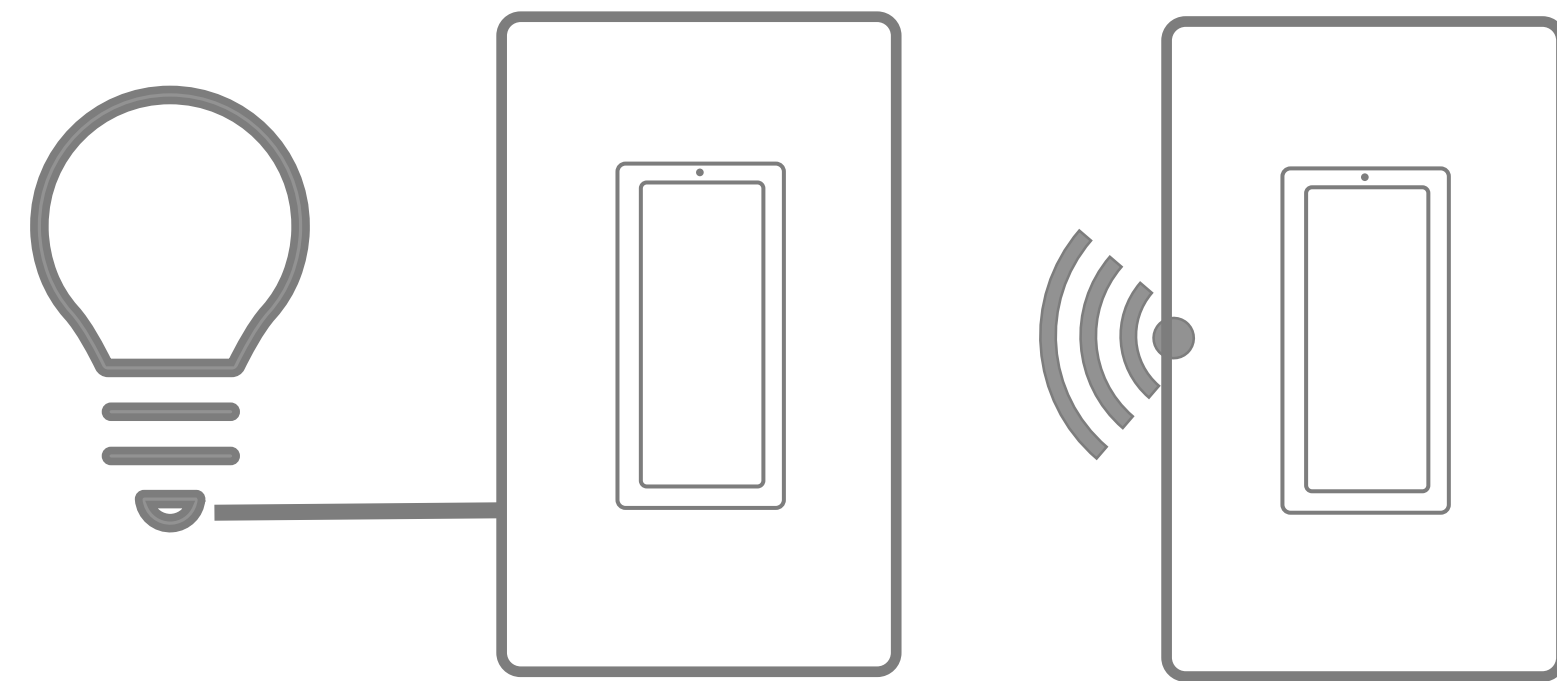

**Switch 1:**  
wires to load

**Switch 2:**  
wirelessly mounts  
to any surface or  
over existing back  
box

Devices come pre-paired.  
No setup needed.

## 3 Configurations:

3-Way Switch Kit

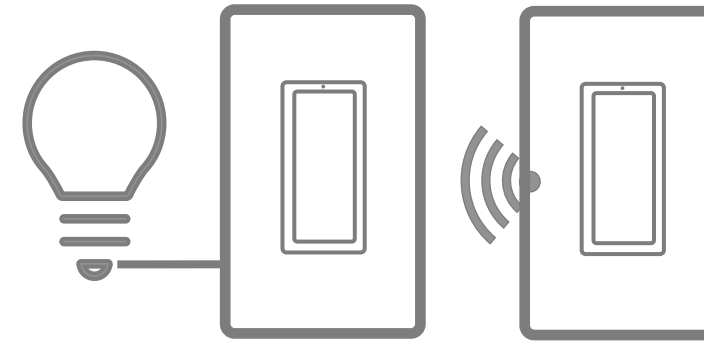

3-Way Dimmer Kit

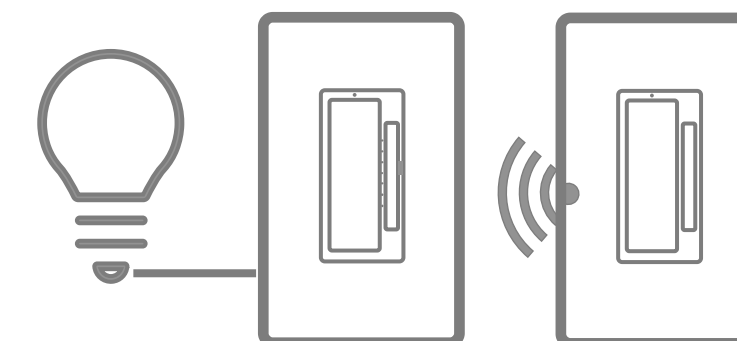

Switched Outlet Kit

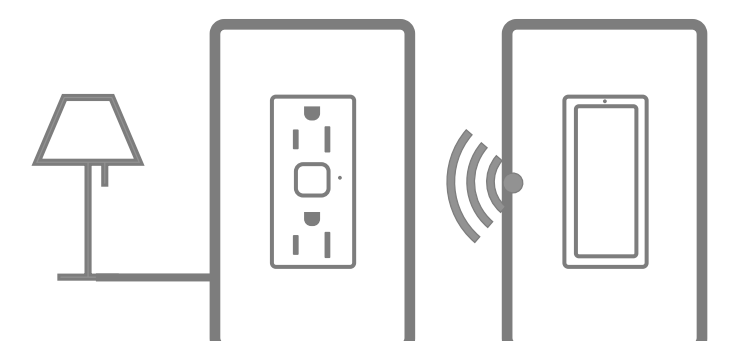

**Expand:** add  
additional devices  
to expand to  
4 way, etc.

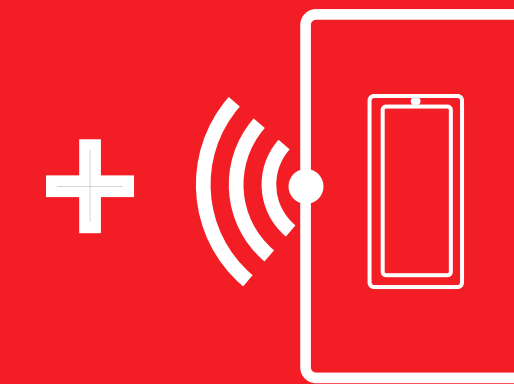

**Connect:** add a  
gateway for more  
control.

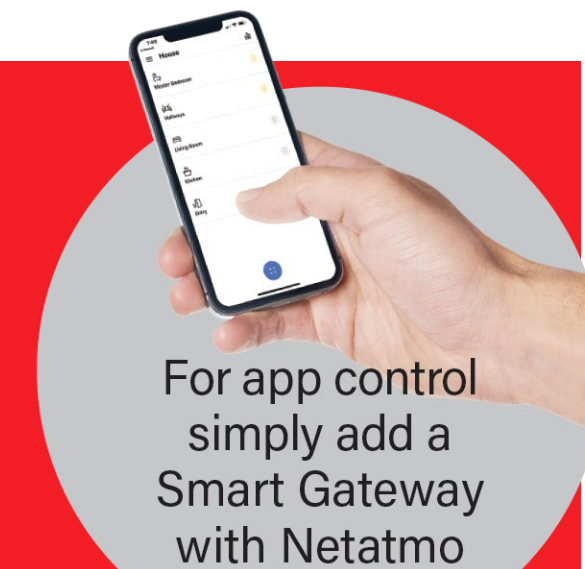

For app control  
simply add a  
Smart Gateway  
with Netatmo



# PREFERRED Contractor Network



adorne® & radiant®  
WITH  
Netatmo

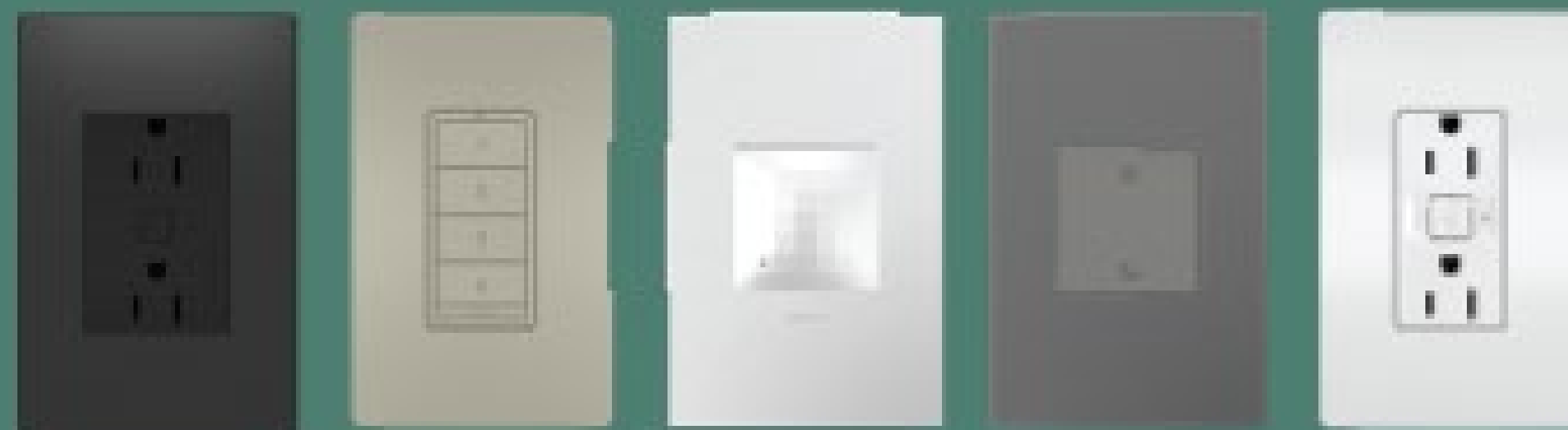

## EVERY 6<sup>TH</sup> SYSTEM STARTS ON US!

### NETWORK BENEFITS

- Free “with Netatmo” starter system with completion of required training
- Access to Preferred Contractor marketing materials including free van decal
- For every 5 Gateways installed, the 6<sup>th</sup> one is on us.

PROPRIETARY AND CONFIDENTIAL INFORMATION



designed to be better.

# Need Support

---

**1 Fastest Support**  
for distributors, contractors & homeowners

Call Technical Support  
877-833-3303  
[smartlights@legrand.us](mailto:smartlights@legrand.us)

**2 Self Help**  
for distributors, contractors & homeowners

Visit our help center  
[qna.legrand.com](http://qna.legrand.com)

**3 On-Demand Training**  
for electricians

 [View](#) our install & help videos on or YouTube.

OR







THANK YOU!

Questions welcomed.